

1

BRAVILOR BONAMAT



HWA 6



HWA 6D



HWA 14 / HWA 4



HWA 14D / HWA 4D



HWA 21 / HWA 5



User manual
 Mode d'emploi Utilisateur
 Gebraucher Handbuch
 Gebruiksaanwijzing
 Användarmanualen
 Brukerhåndbok
 Brugsanvisningen
 Käyttäjän käsikirja
 Manual del usuario
 Manual do utilizador
 Manuale per l'utente
 Εγχειρίδιο χρήσης
 Příručka pro uživatele
 Podręcznik użytkownika
 Manualul utilizatorului
 Руководство пользователя
 Kullanicı kilavuzu
 使用手册
 ユーザーマニュアル
 사용자 설명서

Model nr.: HWA06-001
 HWA06-002

HWA14-001
 HWA14-003
 HWA14-004
 HWA14-005
 HWA14-006
 HWA14-007
 HWA14-008
 HWA14-009
 HWA14-010

HWA21-001
 HWA21-002
 HWA21-003
 HWA21-004



English
Français
Deutsch
Nederlands
Svenska



Norsk
Dansk
Suomi
Español
Português

Information		Informasjon
Information		Information
Information		Informaatio
Informatie		Información
Information		Informação
Table of contents		Innholdsfortegnelse
Table des matières		Indholdsfortegnelse
Inhaltsangabe		Sisällysluettelo
Inhoudsopgave		Contenido
Innehållsförteckning		Indice
Safety book		Sikkerhetsbok
Sommaire des sécurités		Sikkerhedsbog
Sicherheitsvorschriften		Turvallisuusohjeet
Veiligheidsboek		Libro de seguridad
Säkerhetsföreskrifter		Instruções de segurança
Handling		Beijene
Fonctionnement		Beijening
Bedienung		Käsittely
Bedienen		Operación
Handhavande		Execução
Installation		Installasjon
Installation		Installation
Installation		Asennus
Installieren		Instalar
Installation		Instalação
Energy saving		Energisparmodus
Économie d'énergie		Energispartilstand
Energiesparmodus		Virransäästötila
Energiespaarstand		Ahorro de energía
Energisparlage		Economia de energia









Cleaning, daily		Daglig vask
Nettoyage quotidien		Rengøring, daglig
Reinigung, täglich		Päivittäinen puhdistus
Schoonmaken, dagelijks		Limpeza diária
Daglig rengøring		Limpeza diária
Programming		Programmering
Programmation		Programmering
Programmieren		Ohjelmointi
Programmeren		Programar
Programmering		Programação
Descaling		Rensing
Détartrage		Afkalkning
Entkalkung		Kalkinpoisto
Ontkalken		Descalcificación
Avkalkning		Descalcificação
Boiling Temperature		Fastsettelse av kokepunktet
Détermination d'ébullition		Kogepunktet
Siedepunktermittlung		bestemmelse
Kookpunt bepalen		Kiehumispiste
Fastställning av kokpunkt		määrittäminen
		Temperatura de ebullición
		Temperatura de ebulição
Calibration		Kalibrering
Calibrage		Kalibrering
Kalibrierung		Kalibrointi
Kalibratie		Mover
Kalibrering		Mover
Moving		Flytte
Déménagement		Flytning
Versetzen		Liikkua
Verplaatsen		Mover
Flytta		Mover
Messages		Meldinger
Messages		Beskeder
Meldungen		Viestit
Meldingen		Mensajes
Meddelanden		Mensagens





it : Per la Sua lingua consultare la fine di questo documento.
 el : Για τη δική σας γλώσσα δούμε το τέλος αυτού του εγγράφου.
 cz : Volba jazyka je popsána na konci následující stránky tohoto návodu.
 pl : Szukaj swojego języka na ostatnich stronach dokumentu.
 ro : Citiți pentru limba dvs pagina atașată la spatele acestui document.
 ru : Вкладыш на Вашем языке в конце этого документа.
 tr : Diliniz için arkadaki katlı sayfaya bakınız.
 ch : 為了你自己的語言：請參本文檔的末尾。
 jp : 自分自身の言語の場合：この文書の末尾を参照してください。
 kor : 자신의 언어로이 문서의 끝 부분을 참조하십시오.



English
Français
Deutsch
Nederlands
Svenska

Norsk
Dansk
Suomi
Español
Português

Optional Option Produktliste Optioneel Tilval		Valgfri Valgbar Valinnainen Opcional Opcional
Accessories Accessories Zubehör Toebehoren Tillbehör		Tilbehør Valgbar Lisälaitteet Accesorios Acessórios
Manual dosing Dosage manuel Hand-Dosierung Handmatig doseren Manuellt dosering		Manuellt dosering Manuel dosering Manuaalinen annostelu Dosificación manual Dosagem manual
Automatic dosing Dosage automatique Automatische Dosierung Automatisch doseren Automatisk dosering		Automatisk dosering Automatisk dosering Automaattinen annostelu Dosificación automática Dosagem automática
Wait Patienter Warten Wachten Vänta		Vent Vent Odota Esperar Aguardar
Detergent Détergent Spülmittel Afwasmiddel Rengöringsmedel		Vaskemiddel Rengöringsmedel Puhdistusaine Detergente Detergente
Rinse Rincer Spülen Afspoelen Sköljning Counter Compteur Zähler Teller Räkare		Skylle Rensning Huuhtelee Aclarar Enxaguamento
		Telleverk Tæller Laskin Contador Contador

Safety gloves Gants de sécurité Schutzhandschuhe Veiligheids- handschoenen Skydds handskar		Hansker Sikkerheds handsker Suojahanskat Zapatos de seguridad Luvas de protecção
Safety goggles Lunettes de sécurité Schutzbrille Veiligheidsbril Skydds glasögon		Vernebriller Sikkerhedsbriller Suojalasit Gafas de seguridad Oculos de protecção
Hot liquid Liquide chaud Heiße Flüssigkeit Hete vloeistof Varma drycker		Varm væske Varm flydende Kuuma nestettä Líquido caliente Líquido quente
Steam! Vapeur! Dampf! Stoom! Anga!		Damprom! Damp! Höyryä! Vapor! Vapor!
Call distributor Appelez votre distributeur Händler anrufen Verkoopkantoor bellen Ring Leverantör		Ring leverandør Tilkald forhandler Soita jälleenmyyjälle Llame al distribuidor Contacto importador
Flashing Clignotant Blinkend Knipperend Blinkande		Blinker Blinker Viilkuu Parpadeo Piscar
Turn off eco! Désactiver éco! Ausschalten Öko! Schakel eco uit! Eko avstängning!		Øko utkobling! Øko slukke! Eko sammuttamalla! Desactivar eco! Desactivar eco!

**EN****This manual is set up with pictures.**

Reason: language independent; unambiguous; compact!

How to use this manual?

The numbers 1 till 7 refer to the pictures on the previous page.

1. First read the safety instructions (700.403.347 / 700.403.713).
2. Then read the user manual.
3. Study all pictograms and read their meaning.
4. Find the correct chapter and section in the index.

Chapter structure:

5. Chapter with the subjects (red).
6. Instruction pages with actions (red) and pictograms (comments/prohibitions).
7. First read the complete instruction page, then carry out the actions (red).

DE**Dieses Handbuch ist mit Abbildungen aufgebaut.**

Grund: Sprache unabhängig; Eindeutig; Kompakt!
Wie wende ich dieses Handbuch an?

Die Nummern 1 bis 7 verweisen zu den Bildern auf die vorhergehende Seite.

1. Lesen Sie zuerst die Sicherheitsbestimmungen (700.403.347 / 700.403.713).
2. Lesen Sie dann das Gebraucher Handbuch.
3. Studieren Sie alle Pictogramme und lesen Sie Ihre Bezeichnung.
4. Suchen Sie im Index das richtige Kapitel und den Paragraphen.

Aufbau Kapitel:

5. Kapitel mit dem Thema (Rot).
6. Instruktionssseite mit Handlungen (Rot) und Pictogrammen (Gebote/Verbote).
7. Lesen Sie zuerst die ganze Instruktionssseite und führen Sie danach die Handlungen (Rot) durch.

FR**Ce manuel est composé d'images.**

Raison : pas de problème linguistique; aucune ambiguïté ; compact !

Comment utiliser ce manuel ?

Les numéros 1 à 7 renvoient aux images de la page précédente.

1. Tout d'abord lire les mises en garde et directives de sécurité (700.403.347 / 700.403.713)
2. Ensuite lire le manuel de l'utilisateur.
3. Étudier tous les pictogrammes et lire leur signification.
4. Rechercher dans l'index le chapitre et le paragraphe exact.

Structure du chapitre :

5. Chapitre avec le thème abordé (rouge).
6. Page d'instructions avec les opérations à effectuer (rouge) et les petits pictogrammes (obligations/interdictions).
7. Toujours lire la totalité des instructions avant d'exécuter les opérations à effectuer (rouge).

NL**Deze handleiding is opgebouwd uit plaatjes.**

Reden: taalafhankelijk; eenduidig; compact!
Hoe moet ik deze handleiding gebruiken?

De nummers 1 t/m 7 verwijzen naar de plaatjes op de voorgaande pagina.

1. Lees eerst de veiligheidsvoorschriften (700.403.347 / 700.403.713)
2. Lees dan de 'user manual'.
3. Bestudeer alle pictogrammen en lees hun betekenis.
4. Zoek in de index het juiste hoofdstuk en paragraaf op.

Opbouw hoofdstuk:

5. Hoofdstuk met de onderwerpen (rood).
6. Instructiepagina's met handelingen (rood) en pictogrammen (geboden/verboden).
7. Lees eerst de gehele instructiepagina en voer daarna de handelingen (rood) uit.



1.

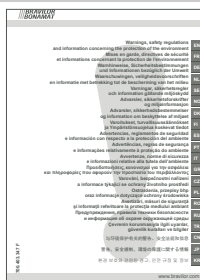

2.

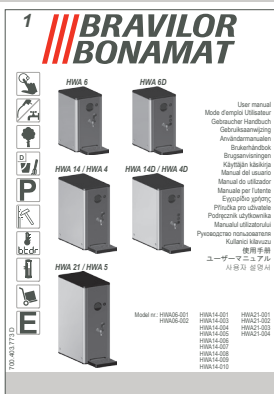

3.

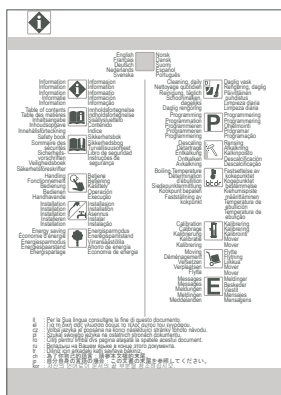

4.

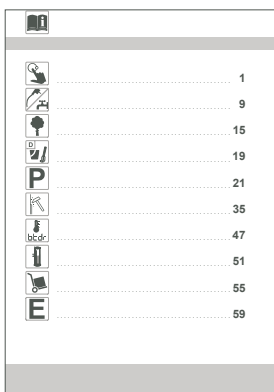

5.

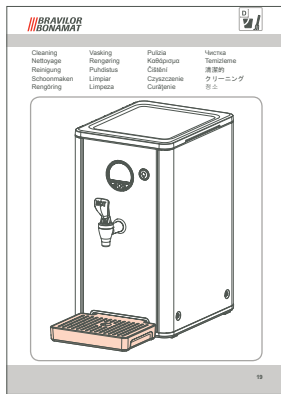

6.

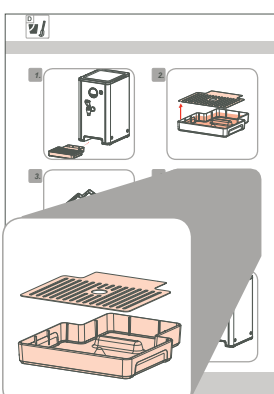

**SE****Denna manual är sammanställd av bilder.**

Orsak: oberoende av språk; tydlig; kompakt!
Hur ska manualen användas?

Siffrorna 1 till 7 hänvisar till bilderna på föregående sida.

1. Läs först säkerhetsinstruktionerna (700.403.347 / 700.403.713).
2. Läs därefter användarmanualen.
3. Studera bildtecknen och förstå deras betydelse.
4. Leta efter rätt kapitel och avsnitt i innehållsförteckningen.

Kapitelstruktur:

5. Kapitel med ämnen (röda).
6. Instruktionssidor med åtgärder (röda) och bildtecken (kommentarer/förbud).
7. Läs först hela instruktionssidan och utför därefter åtgärderna (röda).

NO**Denne håndboken er satt opp med bilder.**

Årsak: Språkuavhengig, entydig, kompakt!
Slik bruker du denne håndboken?

Numrene 1 til 7 henviser til bildene på foregående side.

1. Les først sikkerhetsinstruksjonene (700.403.347 / 700.403.713).
2. Les deretter brukerhåndbok.
3. Studer alle piktogrammer og les betydningen av dem.
4. Finn det riktige kapitlet og avsnittet i stikkordlisten.

Kapittelstruktur:

5. Kapittel med emnene (rødt).
6. Instruksjonssider med handlinger (røde) og piktogrammer (kommentarer/forbud).
7. Les først hele instruksjonssiden, og utfør deretter handlingene (røde).

DK**Denne vejledning er sat op med billeder.**

Årsag: uafhængig af sprog; utvetydig; kompakt!
Hvordan bruges denne vejledning?

Tallene 1 til 7 henviser til billederne på den foregående side.

1. Læs først sikkerhedsanvisningerne (700.403.347 / 700.403.713).
 2. Læs derefter brugsanvisningen.
 3. Studer alle piktogrammer og læs hvad de betyder.
 4. Find det rigtige kapitel og afsnit i indekset.
- Kapitlernes opbygning:*
5. Kapitel med emner (rødt).
 6. Siderne med anvisninger om de handlinger, der skal udføres (røde), og piktogrammer (bemærkninger/forbud).
 7. Læs først hele siden med anvisninger, udfør derefter handlingerne (røde).

FI**Tämä käsikirja perustuu kuvien käyttöön.**

Syy: kielestä riippumaton, yksiselitteinen, kompakt!

Kuinka tätä käsikirjaa käytetään?

Numerot 1-7 viittaavat edellisen sivun kuviin.

1. Lue ensin turvaohjeet (700.403.347 / 700.403.713).
 2. Lue sitten käyttäjän käsikirja.
 3. Tutustu kaikkiin piktogrammeihin ja lue niiden merkitys.
 4. Etsi vastaava luku ja kappale hakemistosta.
- Lukujen rakenne:*
5. Luku, jossa on kohteet (punainen).
 6. Ohjesivut, joilla esitetään toimet (punainen) ja piktogrammit (huomautukset/kiellot).
 7. Lue ensin ohjesivu kokonaan ja suorita sitten toimet (punainen).



ES

Este manual se ha elaborado con ilustraciones.

Motivo: ¡independencia del idioma; nada ambiguo; más compacto!

¿Cómo se utiliza este manual?

Los números del 1 al 7 hacen referencia a las ilustraciones de la página anterior.

1. Lea en primer lugar las instrucciones de seguridad (700.403.347 / 700.403.713).
2. A continuación, lea el manual del usuario.
3. Estudie detenidamente todos los pictogramas y lea su significado.
4. Encuentre el capítulo y la sección correctos en el índice.

Estructura de cada capítulo:

5. Capítulo con los temas (rojo).
6. Páginas de instrucciones con acciones (rojo) y pictogramas (comentarios/prohibiciones).
7. Primero lea completamente la página de instrucciones, luego lleve a cabo las acciones (rojo).

PT

Este manual é composto por imagens.

Razão: não depende de qualquer idioma; não é ambíguo; compacto!

Como utilizar este manual?

Os números de 1 a 7 referem-se às imagens na página anterior.

1. Leia em primeiro lugar as instruções de segurança (700.403.347 / 700.403.713).
2. De seguida, leia o manual do utilizador.
3. Estude todos os ícones e leia os seus significados.
4. Procure o capítulo e secção correctos no índice.

Estrutura dos capítulos:

5. Capítulo com o assunto (vermelho).
6. Página de instruções com procedimentos (vermelho) e ícones (comentários/proibições).
7. Leia em primeiro lugar a página de instruções completa, e efectue os procedimentos (vermelho).

IT

Il presente manuale è stato realizzato con illustrazioni.

Motivo: non ha limiti di lingua, è chiaro e compatto!

Consultazione del manuale:

I numeri da 1 a 7 fanno riferimento alle immagini sulla pagina precedente.

1. Leggere prima le norme di sicurezza (700.403.347 / 700.403.713).
2. Poi leggere il manuale per l'utente.
3. Studiare tutti i pittogrammi e leggerne il significato.
4. Individuare nell'indice il capitolo e la sezione corretti.

Organizzazione dei capitoli:

5. Capitolo con i soggetti (rosso).
6. Pagine con istruzioni e azioni (in rosso) e pittogrammi (commenti / divieti).
7. Leggere prima tutte le istruzioni e poi eseguire le azioni (in rosso).

EL

Το παρόν εγχειρίδιο αποτελείται από εικόνες.

Αιτία: : ανεξάρτητο τη από γλώσσα, μικρό μέγεθος!

Πώς θα χρησιμοποιήσετε το εγχειρίδιο?

Οι αριθμοί 1 έως 7 αναφέρονται στις εικόνες της προηγούμενης σελίδας.

1. Διαβάστε πρώτα τις οδηγίες ασφαλείας (700.403.347 / 700.403.713).
2. Μετά διαβάστε το «εγχειρίδιο χρήσης»
3. Μελετήστε όλα τα εικονογράμματα και διαβάστε την ερμηνεία τους.
4. Βρείτε στο ερμητήριο, το σωστό κεφάλαιο και την ενότητα.

Δομή κεφάλαιο:

5. Κεφάλαιο με τα θέματα (κόκκινο).
6. Σελίδες με οδηγίες για ενέργειες (κόκκινο) και εικονογράμματα (σχόλια / απαγορεύσεις).
7. Πρώτα διαβάστε ολόκληρη την σελίδα με τις οδηγιών, και μετά πραγματοποιήσε τις ενέργειες (κόκκινο).

**CZ****Tato příručka je opatřena obrázky.**

Důvod: srozumitelnost bez ohledu na jazyk; jednoznačnost; ucelenost!

Jak tento manuál používat?

Císla od 1 do 7 označují obrázky na předchozí straně.

1. Nejprve si přečtete bezpečnostní pokyny (700.403.347 / 700.403.713).
2. Poté si prostudujete uživatelskou.
3. Dále si prostudujete všechny symboly a jejich významy.
4. V rejstříku vyhledejte příslušnou kapitolu a odstavec.

Clănení kapitoly:

5. Kapitola venovaná tématu (červené označení).
6. Instrukční stránky se znázorněnými postupy (červené označení) a symboly (poznámky/zákazy).
7. Nejprve si přečtete celou instrukční stránku a poté provedete potřebné úkony (červené označení).

PL**Niniejszy podręcznik składa się z rysunków.**

Powód: jest czytelny niezależnie od wersji językowej; jednoznaczny; zwięzły!

Jak korzystać z podręcznika?

Numbry od 1 do 7 dotyczą rysunków na poprzedniej stronie.

1. Najpierw zapoznaj się z instrukcjami bhp (700.403.347 / 700.403.713).
2. Następnie przeczytaj podręcznik użytkownika.
3. Zapoznaj się z wszystkimi piktogramami i ich znaczeniem.
4. Znajdź właściwy rozdział i część w indeksie. *Struktura rozdziału:*
5. Rozdział z tematami (zaznaczony na czerwono).
6. Strony z instrukcjami dotyczące działania (zaznaczone na czerwono) i piktogramy (uwagi/zakazy).
7. Najpierw zapoznaj się z wszystkimi instrukcjami, a następnie wykonaj czynności (zaznaczone na czerwono).

RO**Acest manual este compus din imagini.**

Motivul: independent de limbă; fără echivoc; compact!

Cum se utilizează acest manual

Numerele de la 1 până la 7 se referă la imaginile de pe pagina anterioară.

1. Mai întâi citiți instrucțiunile de siguranță (700.403.347 / 700.403.713).
2. Apoi citiți manualul utilizatorului.
3. Studiați toate pictogramele și citiți semnificația acestora.
4. Căutați capitolul și paragraful corect în cuprins.

Structura capitolului:

5. Capitolul cu temele principale (roșu).
6. Paginile de instrucțiuni cu acțiunile care trebuie întreprinse (roșu) și pictograme (comentarii/interdicții).
7. Mai întâi citiți toată pagina de instrucțiuni, apoi executați acțiunile (roșu).

RU**Это руководство устанавливается с картинками.**

Причина: независимость от языка; четкость; компактность!

Как пользоваться данным руководством?

Номера от 1 до 7 ссылаются на изображения на предыдущей странице.

1. Сначала прочитайте правила техники безопасности (700.403.347 / 700.403.713).
2. Затем прочитайте руководство пользователя.
3. Изучите все пиктограммы и прочитайте их значения.
4. Найдите правильную главу и раздел в индексе. *Структура главы:*
5. Глава с объектами (красная).
6. Страницы инструктажа с действиями (красные) и с пиктограммами (комментарии/запреты).
7. Сначала прочитайте полностью страницу инструктажа, затем выполните действия (красные).



TR

Bu kılavuz resimli olarak hazırlanmıştır.
Sebeap: dilden bağımsızlık; net anlaşılabilirlik; kısalık!

Bu kılavuzu nasıl kullanmalı?

1 ile 7 arasındaki sayılar önceki sayfadaki resimleri gösterir.

1. Önce güvenlik talimatlarını okuyun (700.403.347 / 700.403.713).
2. Sonra kullanıcı kılavuzu.
3. Tüm sembollerini ve anlamlarını inceleyin.
4. Dizinde uygun kısmı ve bölümü bulun.

Kısım yapısı:

5. Konulara göre kısımlar (kirmizi).
6. Resimlerin altında işlemler (kirmizi) ve semboller (notlar/uyarılar).
7. Önce talimat sayfasının tamamını okuyun, sonra işlemleri (kirmizi) uygulayın.

JP

このマニュアルはイラストで構成されています。

その理由：言語を選ばない；明白；コンパクト！

このマニュアルの使い方？

1から7は前ページのイラストを参照して下さい。

1. 最初に安全上の注意をお読みください (700.403.347 / 700.403.713)。
2. ユーザーマニュアルをお読みください。
3. 全ての絵文字の意味について学び、その意味を理解してください。
4. 探している章とセクションを目次から見つけて下さい。

証の構成：

5. 章と主題。(赤)
6. イラストの下に行動指示(赤)と絵文字(コメント/禁止事項)。
7. 最初にインストラクションページを最後まで読み、行動指示に従って下さい。(赤)

CN

本手册包含图像。

此手册设置了许多图片。

原因：语言独立；明确；小巧！

如何使用此手册？

数字1至7是指先前页面上的图片。

1. 首先阅读安全须知 (700.403.347 / 700.403.713)。
2. 然后阅读用户手册。
3. 研究所有象形和了解它们的含义。
4. 在目录查找正确的章节。

章节结构：

5. 主题章节 (红色)。
6. 活动性教学网页 (红色) 和象形图 (评论/禁止行为)。
7. 首先阅读完整的说明页面，然后进行操作 (红色)。

KR

다음의 매뉴얼은 사진으로 구성되어 있다.











이유: 언어는 독립적이고 분명하며 집약적이기 때문이다!

어떻게 이 매뉴얼을 사용하나?

숫자 1부터 7은 이전 페이지에 있는 사진을 언급한다.

1. 먼저 안전 지침을 읽는다. (700.403.347 / 700.403.713).
 2. 사용자 매뉴얼.
 3. 모든 그림을 연구하고 그것의 의미를 이해한다.
 4. 인덱스에서 올바른 부분을 찾는다.
- 챕터 구조:
5. 제목이 달린 챕터 부분 (붉은 글씨).
 6. 실행(붉은 글씨)과 그림(코멘트/금지)이 있는 지침 페이지.
 7. 먼저 전체 지침서를 읽고, 실행(붉은 글씨)에 옮긴다.



	1
	9
	15
	19
	21
	35
	47
	51
	55
	59

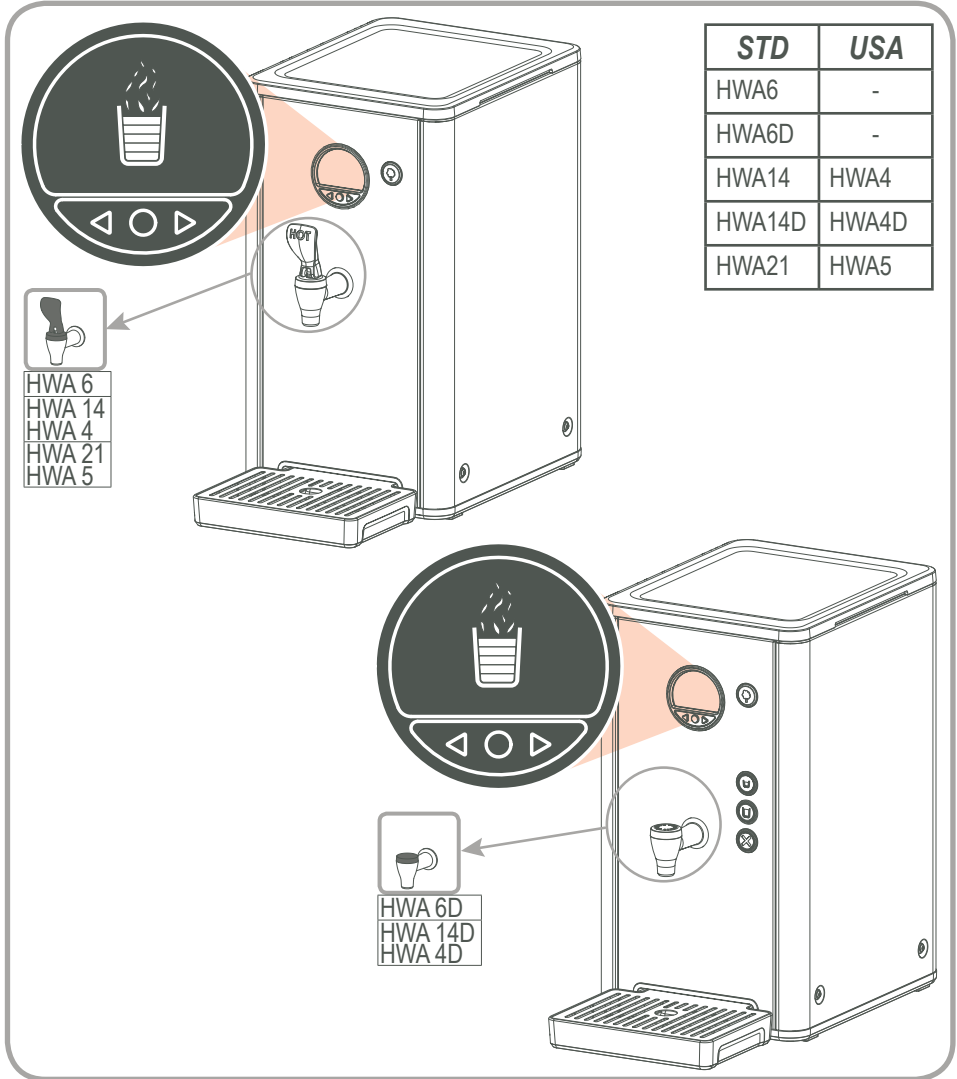

STD	USA
HWA6	-
HWA6D	-
HWA14	HWA4
HWA14D	HWA4D
HWA21	HWA5

HWA 6
HWA 14
HWA 4
HWA 21
HWA 5

HWA 6D
HWA 14D
HWA 4D



- GB** 1. Menu buttons
2. Unit volume
3. Unit of temperature
4. Text / value
5. Descaling
6. Water filter
7. Counters
8. Free-flow
9. Free-flow on/off
10. Current state
11. Temperature
12. Dosage blocked
13. See the manual
14. Energy saving (eco)
15. Eco convenience / Time
16. Smart eco
17. Smart eco on/off
18. Days

- FR** 1. Touches de menu
2. Unité de volume
3. Unité de température
4. Text / valeur
5. Détartrage
6. Filtre à eau
7. Compteurs
8. Volume variable
9. Volume variable marche/arrêt
10. Etat actuel
11. Température
12. Dosage bloqués
13. Consultez le manuel
14. Economie d'énergie (éco)
15. Eco commodité / Temps
16. Eco intelligent
17. Eco intelligent marche/arrêt
18. Journées

- DE** 1. Menütasten
2. Volumeneinheit
3. Temperatureinheit
4. Text
5. Entkalkung
6. Wasserfilter
7. Zähler
8. Freilauf
9. Freilauf Ein/Aus
10. Aktueller Zustand
11. Temperatur
12. Dosierung blockiert
13. Siehe Handbuch
14. Energiesparmodus (Öko)
15. Oko Bequemlichkeit / Zeit
16. Smart-Öko
17. Smart-Öko Ein/Aus
18. Tage

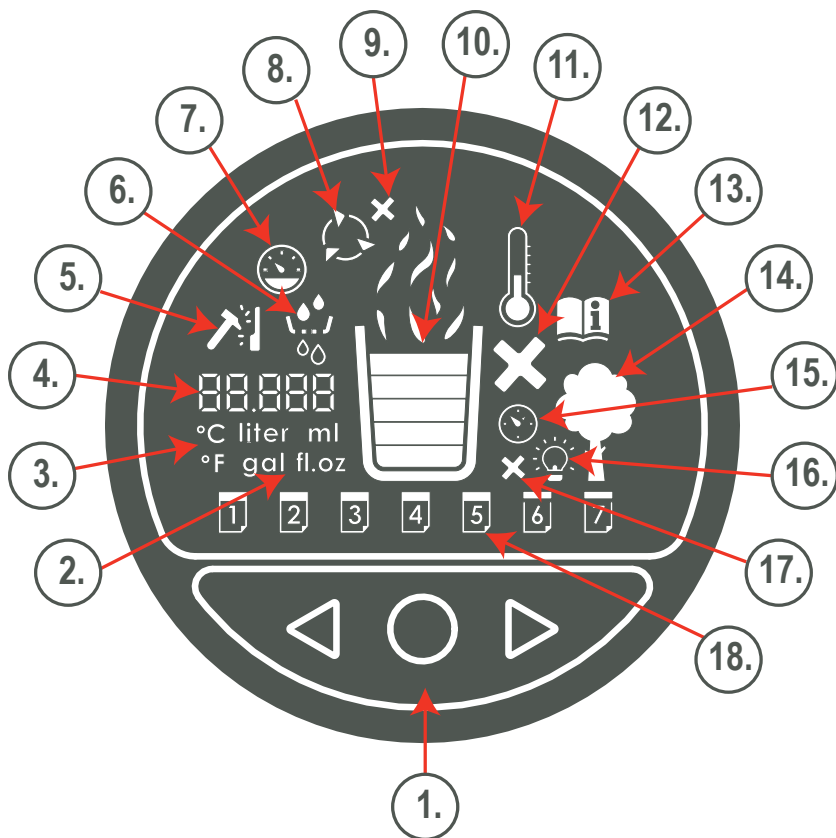



- NL** 1. Menu-toetsen
2. Volume-eenheid
3. Temperatuureenheid
4. Tekst
5. Ontkalken
6. Waterfilter
7. Tellers
8. Free flow
9. Free flow aan/uit
10. Actuele status
11. Temperatuur
12. Dosering geblokkeerd
13. Raadpleeg handleiding
14. Energiespaarstand (eco)
15. Eco convenience / Tijd
16. Smart eco
17. Smart eco aan/uit
18. Dagen
- SE** 1. Menyknappar
2. Volymenhet
3. Temperaturenhet
4. Text
5. Avkalka
6. Vattenfilter
7. Räknare
8. Kontinuerligt flöde
9. Kontinuerligt flöde på/av
10. Den nuvarande situationen
11. Temperatur
12. Dosering blockerad
13. Hänvisa till manuell
14. Energisparlage (eko)
15. Eko bekvämlighet / Tid
16. Smart eko
17. Smart eko på/av
18. Dagar
- NO** 1. Meny-taster
2. Volumenhet
3. Temperaturenhet
4. Tekst
5. Avkalk
6. Vannfilter
7. Teller
8. Fri flyt
9. Fri flyt på/av
10. Nåværende tilstand
11. Temperatur
12. Dosering blokkert
13. Referere til manual
14. Energisparmodus (øko)
15. Øko convenience / Tid
16. Smart øko
17. Smart øko på/av
18. Dager
- DK** 1. Menutaster
2. Volumenenhed
3. Temperatur enhed
4. Tekst
5. Afkalk
6. Vandfiltre
7. Tællere
8. Fortsat strøm
9. Fortsat strøm tænd/sluk
10. Aktuelle tilstand
11. Temperatur
12. Dosering blokeret
13. Se manuel
14. Eneregispartilstand (øko)
15. Øko Convenience / Tid
16. Smart øko
17. Smart øko tænd/sluk
18. Dage
- FI** 1. Valikkonäppäimillä
2. Tilavuus yksikkö
3. Lämpötilän yksikkö
4. Teksti
5. Kalkinpoisto
6. Vedensuodatin
7. Laskurit
8. Jatkuva virtaus
9. Jatkuva virtaus päälle/pois
10. Nykytila
11. Lämpötila
12. Annostus tukossa
13. Katso käsikirja
14. Virransäästötila (eko)
15. Eko mukavuus / Kellonaika
16. Fiksu eko
17. Fiksu eko päälle/pois
18. Päivää
- ES** 1. Botones de menú
2. Unidad de volumen
3. Unidad de temperatura
4. Texto
5. Descalcificar
6. Filtro de agua
7. Contador
8. Flujo continuo
9. Flujo continuo on/off
10. Estado actual
11. La temperatura
12. Dosificación bloqueado
13. Consulte el manual
14. Ahorro de energía (eco)
15. Eco conveniencia / Hora
16. Eco inteligente
17. Eco inteligente on/off
18. Día
- PT** 1. Teclas de menu
2. Unidade de volume
3. Unidade de temperatura
4. Texto
5. Decalcificação
6. Filtro de água
7. Contadores
8. Fluxo contínuo
9. Fluxo contínuo ligar/desligar
10. Estado atual
11. Temperatura
12. Dosagem bloqueado
13. Consulte o manual
14. Economia de energia (eco)
15. Eco conveniência / Tempo
16. Inteligente eco
17. Inteligente eco ligar/desligar
18. Dias
- IT** 1. Tasti menu
2. Unità di volume
3. Unità di temperatura
4. Testo
5. Decalcificazione
6. Filtro dell'acqua
7. Contatori
8. Freeflow
9. Freeflow attiva/disattiva
10. Stato attuale
11. Temperatura
12. Dosaggio bloccato
13. Consultare il manuale
14. Risparmio energetico (eco)
15. Eco convenienza / Orario
16. Inteligente eco
17. Inteligente eco attiva/disattiva
18. Giorni
- GR** 1. Πλήκτρα μενού
2. Μονάδα όγκου νερού
3. Μονάδα θερμοκρασίας
4. Κείμενο
5. Αφαλάτωσης
6. Φίλτρο νερού
7. Μετρητής
8. Ελεύθερης ροής
9. Ελεύθερης ροής ανοιχτ/κλειστ
10. Τρέχουσα κατάσταση
11. Θερμοκρασία
12. Δοσολογία αποκλεισμένη
13. Συμβουλευτείτε το εγχειρίδιο
14. Που εξοικονομεί ενέργεια (eco)
15. Eco ευκολία / Φορά
16. Έξυπνη eco
17. Έξυπνη eco ανοιχτ/κλειστ
18. Ημέρες



- CZ**
1. Tlačítka nabídky
 2. Objem jednotky
 3. Jednotka teploty
 4. Text
 5. Odvápňení
 6. Vodní filtr
 7. Měřiče
 8. Nepřetržitý tok
 9. Nepřetržitý tok zapn/vypn
 10. Aktuální stav
 11. Teplota
 12. Dávkování zablokovány
 13. Obráťte se na návod
 14. Setření energie (eco)
 15. Eco kolaylık / Cás
 16. Inteligentní eco
 17. Inteligentní eco zapn/vypn
 18. Dny

- PL**
1. Przyciski menu
 2. jednostka objętości
 3. Jednostka temperatury
 4. Tekst
 5. Odkamienianie
 6. Filtr wody
 7. Licznika
 8. Ciągły przepływ
 9. Ciągły przepływ wł/wył
 10. Aktualny stan
 11. Temperatura
 12. Dawkowanie zablokowane
 13. Zapoznaj się z instrukcją
 14. Oszczędzanie energii (eco)
 15. Eco wygodna / Czas
 16. Inteligentne eco
 17. Inteligentne eco wł/wył
 18. Dni

- RO**
1. Tastele de meniu
 2. Unitatea de volum
 3. Unitatea de temperatură
 4. Text
 5. Decalcarizare
 6. Filtru de apă
 7. Contoare
 8. Cu curgere liberă
 9. Cu curgere liberă pornit/oprit
 10. Situația actuală
 11. Temperatură
 12. Dozare blocat
 13. Consultați manualul
 14. Economisire energie (eco)
 15. Eco comoditate / Timp
 16. Inteligent eco
 17. Inteligent eco pornit/oprit
 18. Zile

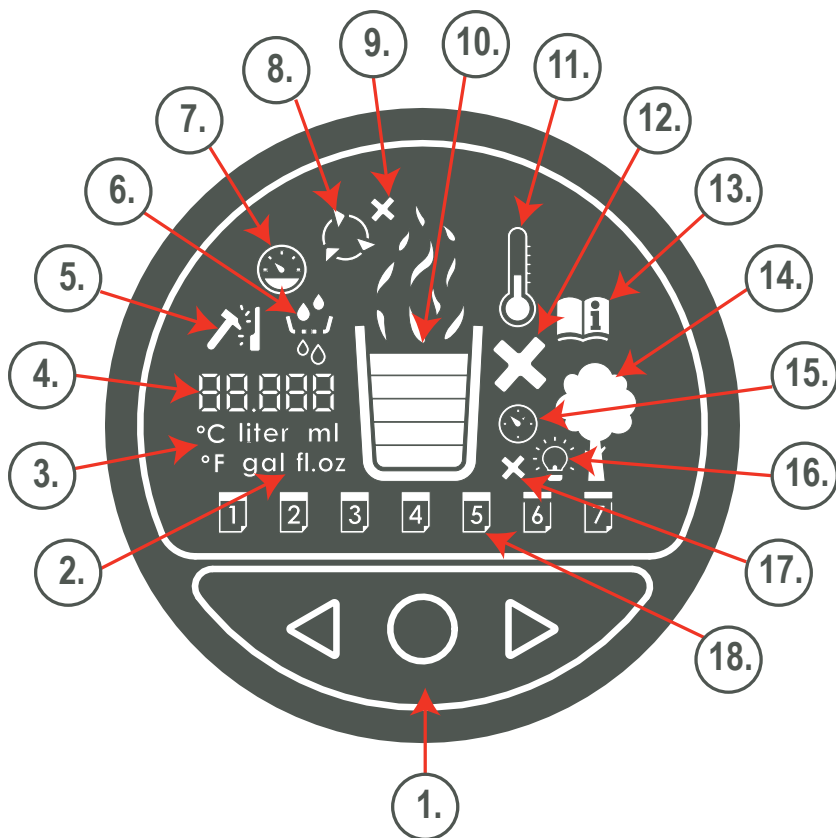



- RU**
1. Кнопки меню
 2. Объем блок
 3. Температура блок
 4. Текст
 5. Декальцификация
 6. Фильтр для воды
 7. Счетчики
 8. Выбеге
 9. Выбеге кл/выкл
 10. Текущее состояние
 11. Температура
 12. Дозировка заблокирован
 13. Обратитесь к руководству
 14. Энергосбережение (эко)
 15. Эко удобство / Время
 16. Смарт эко
 17. Смарт эко вкл/выкл
 18. Дней

- TR**
1. Menü tuşları
 2. Hacmi birimi
 3. Sıcaklık birimi
 4. Metin
 5. Kireçten arndrma
 6. Su filtresi
 7. Sayaçlar
 8. Serbest akış
 9. Serbest akış açık/kapalı
 10. Güncel durum
 11. Sıcaklık
 12. Doz engellendi
 13. El kitabına başvurun
 14. Güç tasarrufu (eko)
 15. Eko kolaylık / Zaman
 16. Akıllı eko
 17. Akıllı eko açık/kapalı
 18. Günler

- CN**
1. 菜單鍵
 2. 水體積單位
 3. 溫度單位
 4. 文本
 5. 除垢
 6. 淨水器
 7. 計數器
 8. 自由流動
 9. 自由流動 开/关
 10. 現狀
 11. 溫度
 12. 用量受阻
 13. 參考手冊
 14. 節能
 15. 節能方便/時間
 16. 智能節能
 17. 智能節能 开/关
 18. 天

- JP**
1. メニューキー
 2. 水量部
 3. 温度単位
 4. テキスト
 5. スケール除去
 6. 浄水器
 7. カウンター
 8. フリーフロー
 9. フリーフロー オン/オフ
 10. 現在の状態
 11. 温度
 12. 投与量はブロックされた
 13. 取扱説明書をご覧ください
 14. パワーセービング (エコ)
 15. コンビニエンスエコ/時間
 16. スマートエコ
 17. スマートエコ オン/オフ
 18. 日

- KO**
1. 메뉴 키
 2. 물의 양 유닛
 3. 온도 단 위
 4. 온도를 제거
 5. 스케일 제거
 6. 물 필터
 7. 카운터
 8. 프리플로우
 9. 프리플로우 사용/미사용
 10. 현재 상태
 11. 온도 차단
 12. 용량 차단을 참조하십시오
 13. 설명서를 참조하십시오
 14. 절전 모드
 15. 편의점 / 시간
 16. 스마트 절전
 17. 스마트 절전 사용/미사용
 18. 일



+

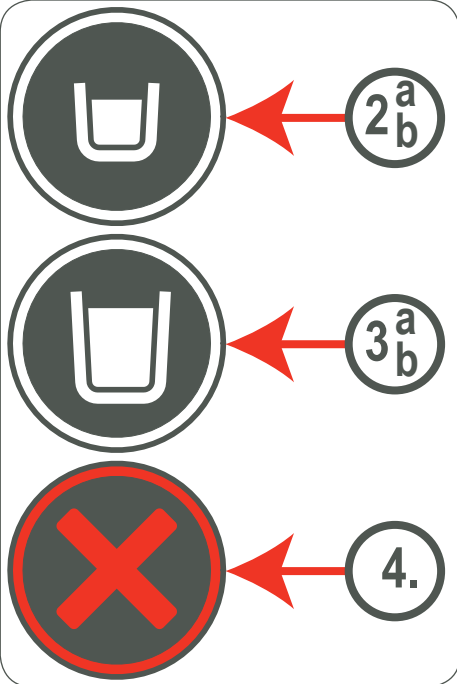



GB 1. ECO-button (> 1 sec.) 2a Push (< 1 sec.) = preset 3a volume 1 / 2 2b Push (> 1 sec.) = freeflow 3b (max. 2L.) 4. Cancel button	FR 1. Bouton-ÉCO (> 1 sec.) 2a Poussée (< 1 sec.) = de la 3a quantité de pré-set 1 / 2 2b Poussée (> 1 sec.) = volume 3b variable (max. 2L.) 4. Bouton d'annulation	DE 1. ÖKO-Taste (> 1 Sek.) 2a Drücken (< 1 Sek.) = vorein- 3a gestellte Menge 1 / 2 2b Drücken (> 1 Sek.) = Freilauf 3b (Max. 2L.) 4. Abbruchtaste
NL 1. ECO-Toets (> 1 sec) 2a Druk (< 1 sec) = vooraf 3a ingestelde hoeveelheid 1 / 2 2b Druk (> 1 sec) = Free flow 3b (max. 2L.) 4. Annuleer toets	SE 1. EKO-Knappen (> 1 sek.) 2a Tryck (< 1 sek.) = förinställd 3a volym 1 / 2 2b Tryck (> 1 sek.) = Kontinuer- 3b ligt flöde (max. 2L.) 4. Avbryt knappen	NO 1. ØKO-knapp (> 1 sek.) 2a Trykk (< 1 sek.) = forhånd- 3a sinnstilt volum 1/2 2b Trykk (> 1 sek.) = Fri flyt 3b (max. 2L.) 4. Avbryt-knapp
DK 1. ØKO-knap (> 1 sek.) 2a Tryk på (< 1 sek.) = forudind- 3a stillet volumen på 1 / 2 2b Tryk på (> 1 sek.) = fortsat 3b strøm (Max. 2L.) 4. Annuller knappen	FI 1. ECO-painike (> 1 sek.) 2a Paina (< 1 sek.) = Ennalta 3a säädetytyn puoli 1 / 2 2b Paina (> 1 sek.) = Jatkuva 3b virtaus (max. 2L.) 4. Peruuta-painike	ES 1. ECO-botón (> 1 seg.) 2a Empuje (< 1 seg.) = la canti- 3a dad de pre-set 1 / 2 2b Empuje (> 1 seg.) = flujo 3b continuo (máx. 2l.) 4. Botón de cancelación
PT 1. Botão de ECO (> 1 seg.) 2a Empurrar (< 1 seg.) = quanti- 3a dade de pré-definir 1 / 2 2b Empurrar (> 1 seg.) = fluxo 3b contínuo (max. 2L.) 4. Botão de cancelamento	IT 1. Pulsante ECO (> 1 sec.) 2a Spingere (< 1 sec.) = volume 3a preimpostato 1 / 2 2b Spingere (> 1 sec.) = freeflow 3b (max. 2L.) 4. Pulsante annulla	GR 1. Κουμπί ECO (> 1 δευ.) 2a Πιέστε (< 1 δευ.) = 3a προκαθορισμένη όγκο 1 / 2 2b Πιέστε (> 1 δευ.) = 3b ελεύθερης ροής (max. 2L.) 4. Κουμπί ακύρωσης
CZ 1. Tlačítko ECO (> 1 sec.) 2a Tlačít (< 1 sec.) = přednas- 3a tavené hlasitosti 1 / 2 2b Tlačít (> 1 sec.) = nepřetržitý 3b tok (max. 2L.) 4. Tlačítko zrušit	PL 1. Przycisk ECO (> 1 sek.) 2a Nacisnąć (< 1 sek.) = zapro- 3a gramowanej objętości 2b Nacisnąć (> 1 sek.) =ciągły 3b przepływ (maks. 2L.) 4. Przycisk anuluj	RO 1. Butonul de ECO (> 1 sec.) 2a Apasă (< 1 sec.) = volumul 3a presetat 1 / 2 2b Apasă (> 1 sec.) = cu curgere 3b liberă (max. 2L.) 4. Butonul de revocare
RU 1. Эко-кнопка (> 1 сек.) 2a Нажмите (< 1 сек.) = 3a Заданного объема 1 / 2 2b Нажмите (> 1 сек.) = выбеге 3b (макс. 2 л.) 4. Кнопка отмена	TR 1. Eko-düğme (> 1 sn.) 2a Tuşuna (< 1 sn.) = önceden 3a ayarlanmış hacmi 1 / 2 2b Tuşuna (> 1 sn.) = serbest 3b akış (max. 2L.) 4. İptal düğmesi	
CN 1. 節能按鈕 (>1秒) 2a 按 (<1秒) = 3a 設定音量1或2 2b 按 (>1秒) = 3b 自由流動 (最大2L) 4. 取消按鈕	JP 1. エコボタン (>1秒) 2a プッシュ (<1秒) : 3a プリセット体積1か2 2b プッシュ (>1秒) : 3b フリーフロー (最大2L) 4. キャンセルボタン	KO 1. 절전버튼 (> 1 초.) 2a 푸시 (<1 초) : 사전 설 3a 정 볼륨 1 또는 2 2b 푸시 (> 1 초) : 프리휠 3b 는 (최대 2L) 4. 취소 버튼을



- GB** *The device is **not** equipped with a backflow preventer!*
- FR** *Le dispositif **n'a pas** été équipé d'un clapet anti-retour!*
- DE** *Das Gerät ist **nicht** mit einem Rückschlagventil ausgestattet!*
- NL** *Het apparaat is **niet** voorzien van een terugstroombeveiliging!*
- SE** *Enheten är **inte** utrustad med en backventil!*
- NO** *Enheten er **ikke** utstyrt med en tilbakeslagsventil !*
- DK** *Enheden er **ikke** udstyret med en tilbageløbssikring!*
- FI** *Laitteessa ei ole varustettu takaiskuventtiilii!*
- ES** *¡El dispositivo **no** está equipado con una válvula antirretorno!*
- PT** *O dispositivo **não** está equipado com uma válvula de retenção!*
- IT** *Il dispositivo **non** è dotato di una valvola di non ritorno!*
- GR** *Η συσκευή **δεν** είναι εξοπλισμένη με βαλβίδα αντεπιστροφής!*
- CZ** *Přístroj **není** vybaven zpětnou zpětným ventilem!*
- PL** *Urządzenie **nie** jest wyposażone w zawór zwrotny!*
- RO** *Aparatul **nu** este echipat cu o supapă de control!*
- RU** *Устройство **не** оснащено обратным клапаном!*
- TR** *Cihaz bir geri akış önleyici ile donatılmış **değildir!***
- CN** *該裝置沒有配備止回閥！*
- JP** *デバイスは、逆流防止が装備されていません！*
- KO** *장치는 체크 밸브를 구비하지 않는다!*



Installation
Installation
Installation
Installeren
Installation

Installasjon
Installation
Asennus
Instalar
Instalação

Installazione
Εγκατάσταση
Instalace
Instalacj
Operare

Устанавливать
Yerleştirme
安装
インストール
설치

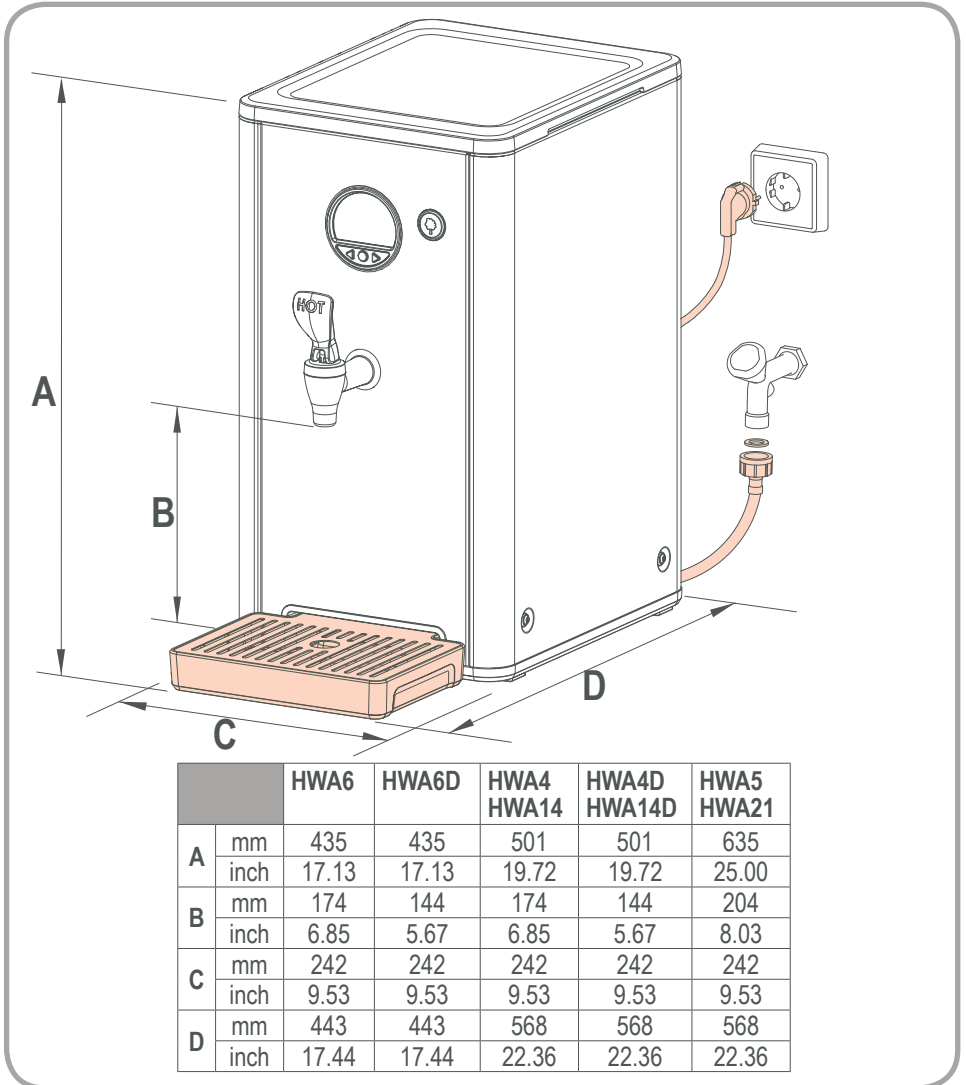

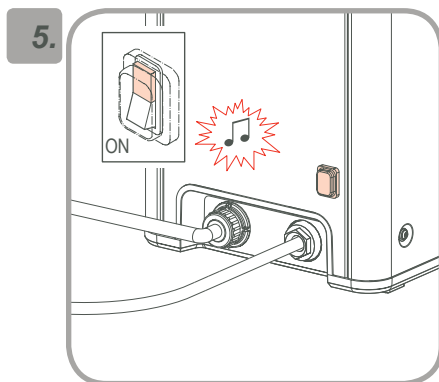
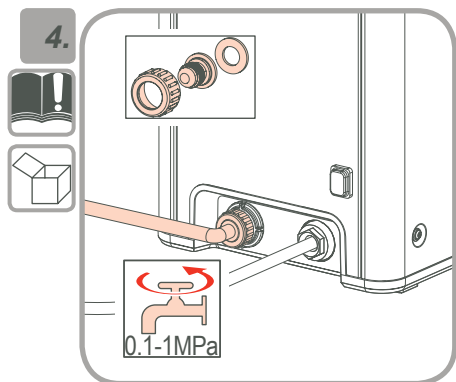
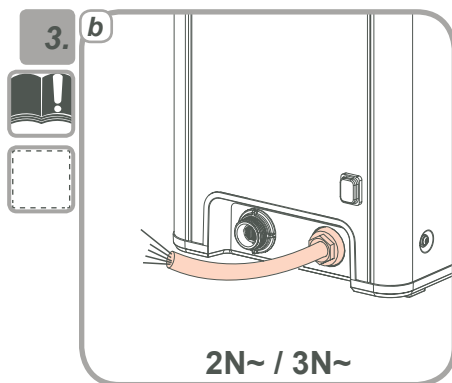
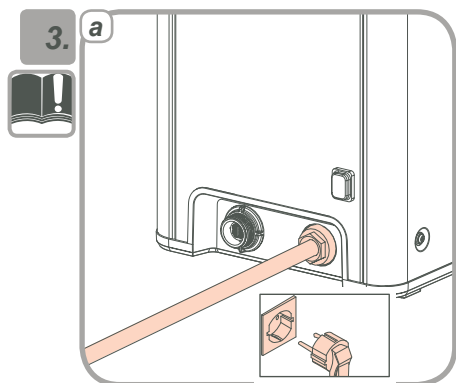
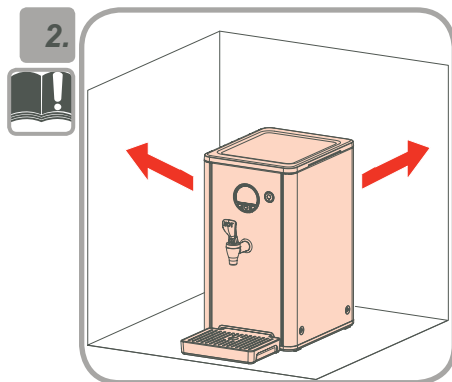
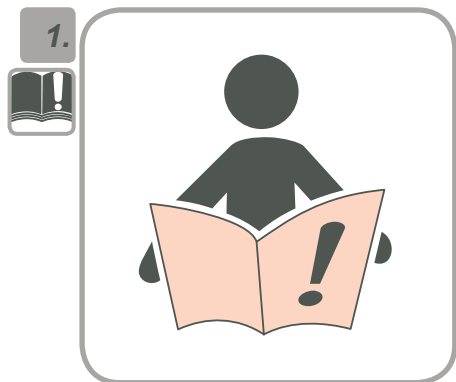



6.

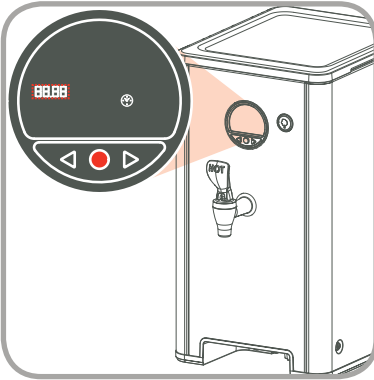

7.

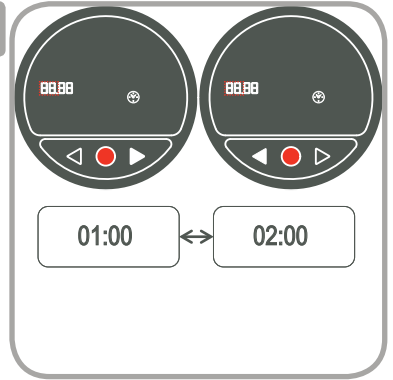

8.

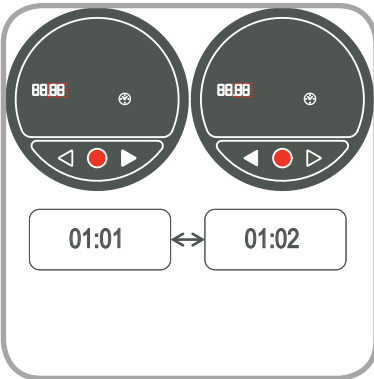

9.

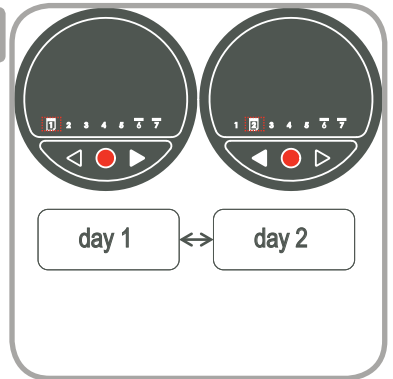

10.

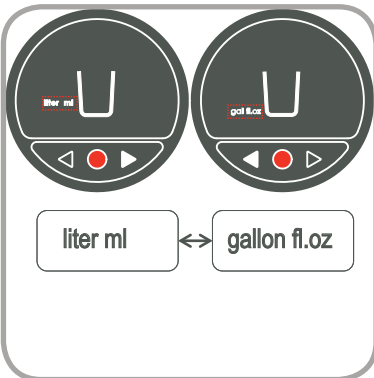

11.

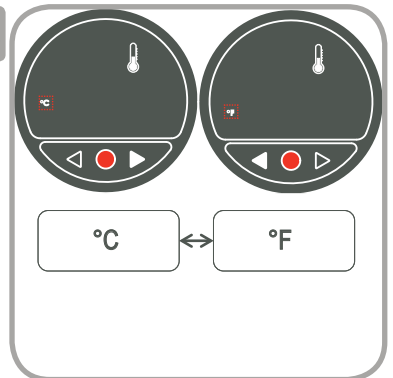



12.

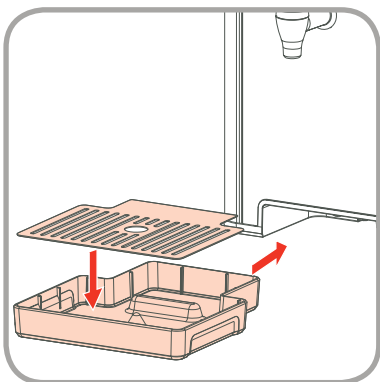

13.

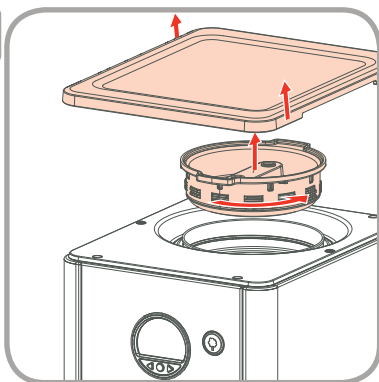

14.

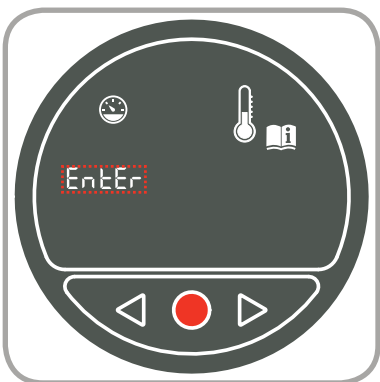

15.

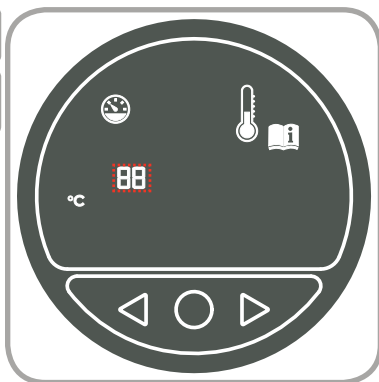

16.

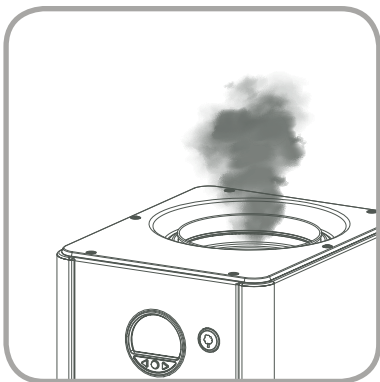

17.



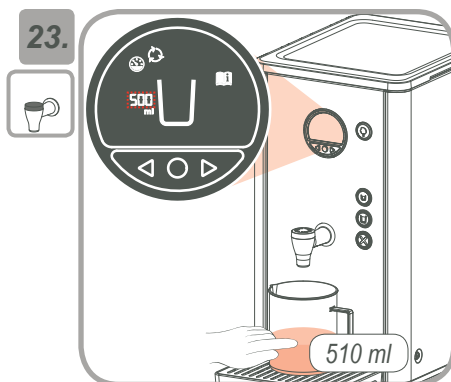
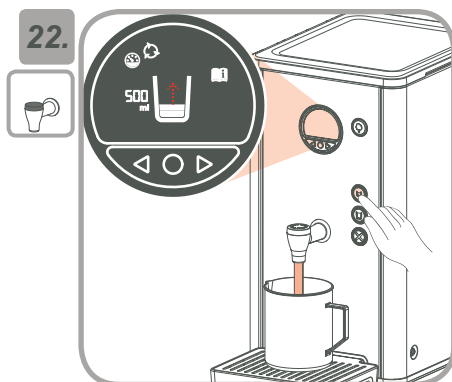
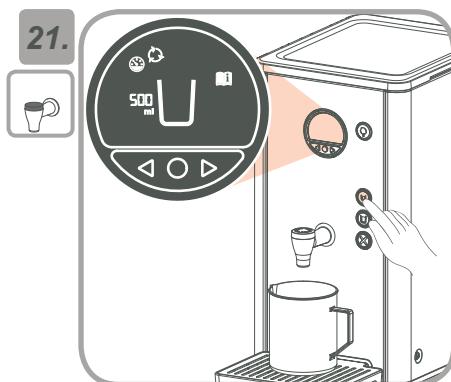
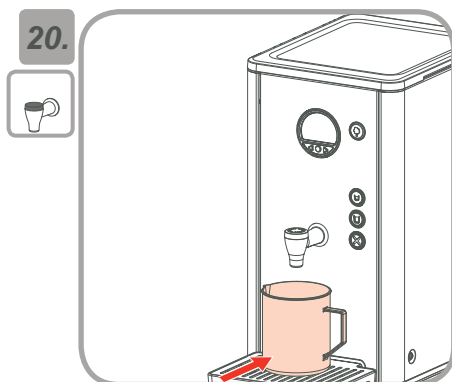
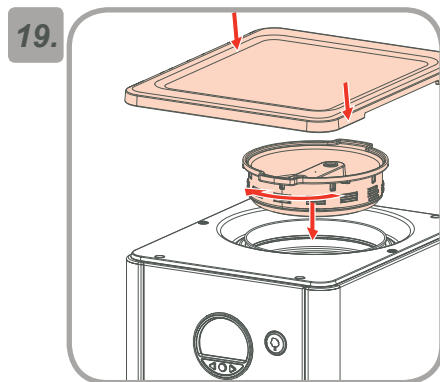
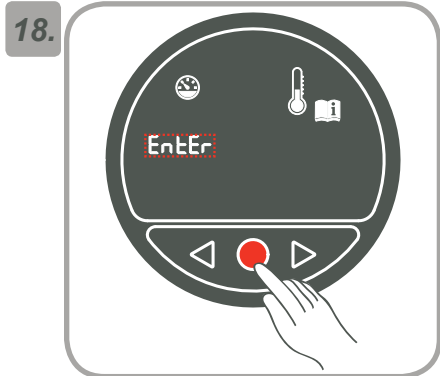

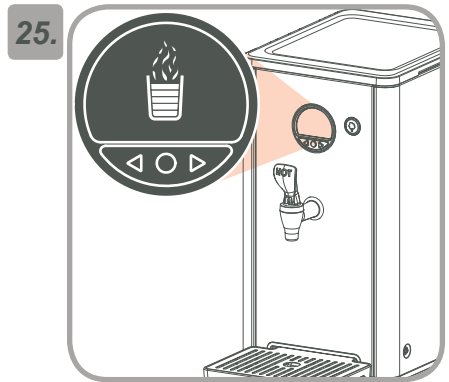
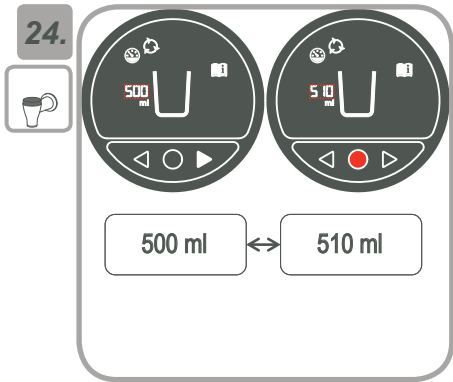



Energy saving	Energisparmodus	Risparmio energetico	Энергосбережение
Économie d'énergie	Energispartilstand	Που εξοικονομεί ενέργεια	Güç tasarrufu
Energiesparmodus	Virransäästötila	Šetření energie	節能
Energiesparstand	Ahorro de energía	Oszczędzanie energii	パワーセービング
Energisparlage	Economia de energia	Economisire energie	절전





energy saving



ECO - off

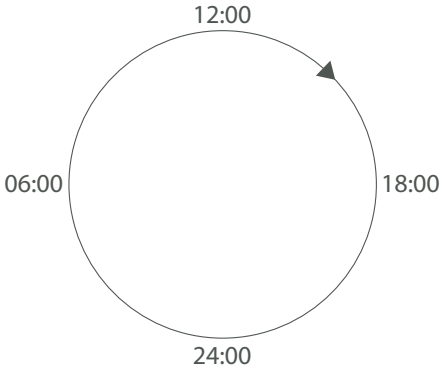

energy saving



ECO - manual

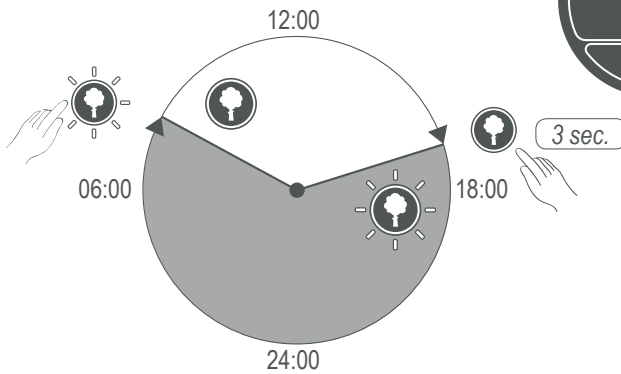



energy saving ●●○

ECO - convenience

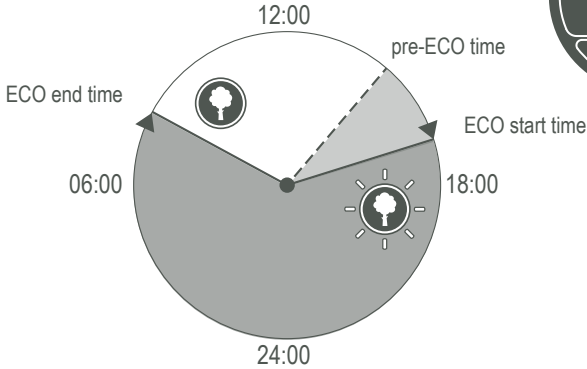

- 1
- 2
- 3
- 4
- 5
- 6
- 7

energy saving ●●●

ECO - smart

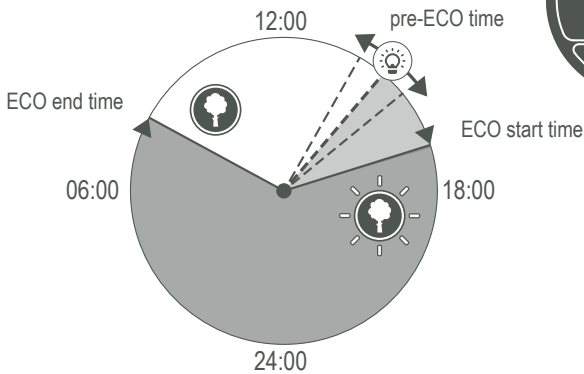

- 1
- 2
- 3
- 4
- 5
- 6
- 7

Cleaning

Nettoyage

Reinigung

Schoonmaken

Rengöring

Vasking

Rengøring

Puhdistus

Limpiar

Limpeza

Pulizia

Καθάρισμα

Čištění

Czyszczenie

Curățenie

Чистка

Temizleme

清潔的

クリーニング

청소



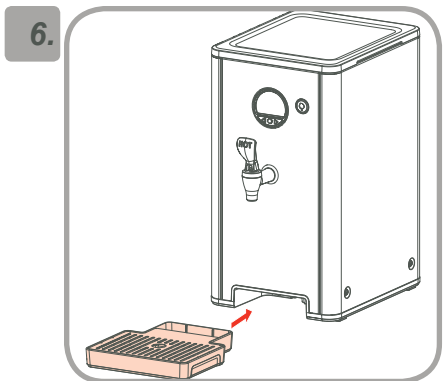
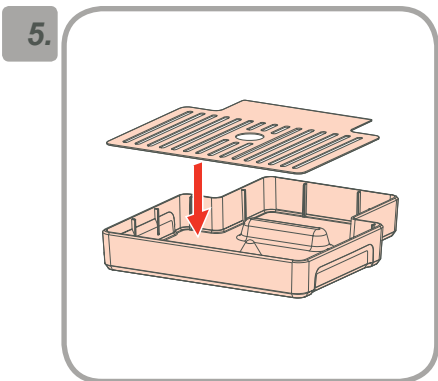
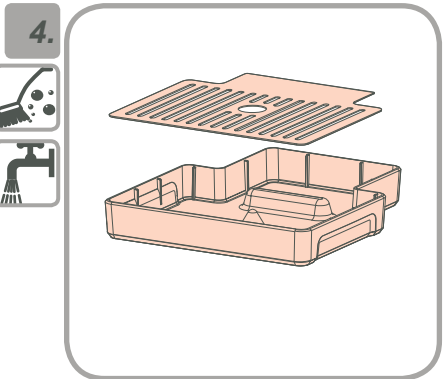
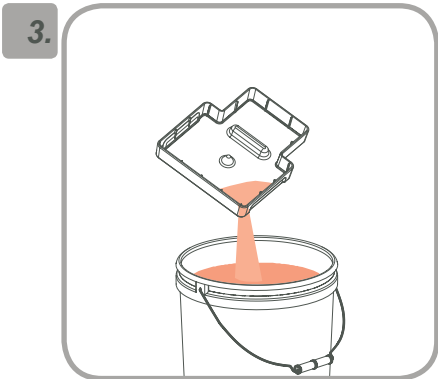
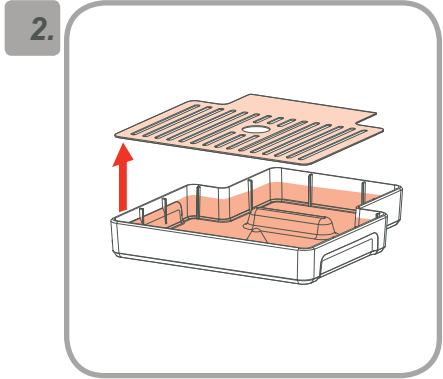
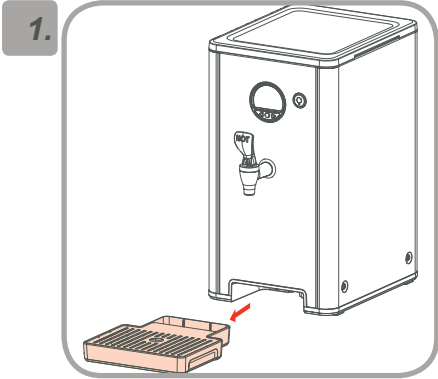

Programming
Programmation
Programmieren
Programmeren
Programmering

Programmering
Programmering
Ohjelmointi
Programar
Programação

Programmazione
Προγραμματισμό
Programování
Programowanie
Programare

Программирование
Programlama
編程的
プログラム
프로그래밍



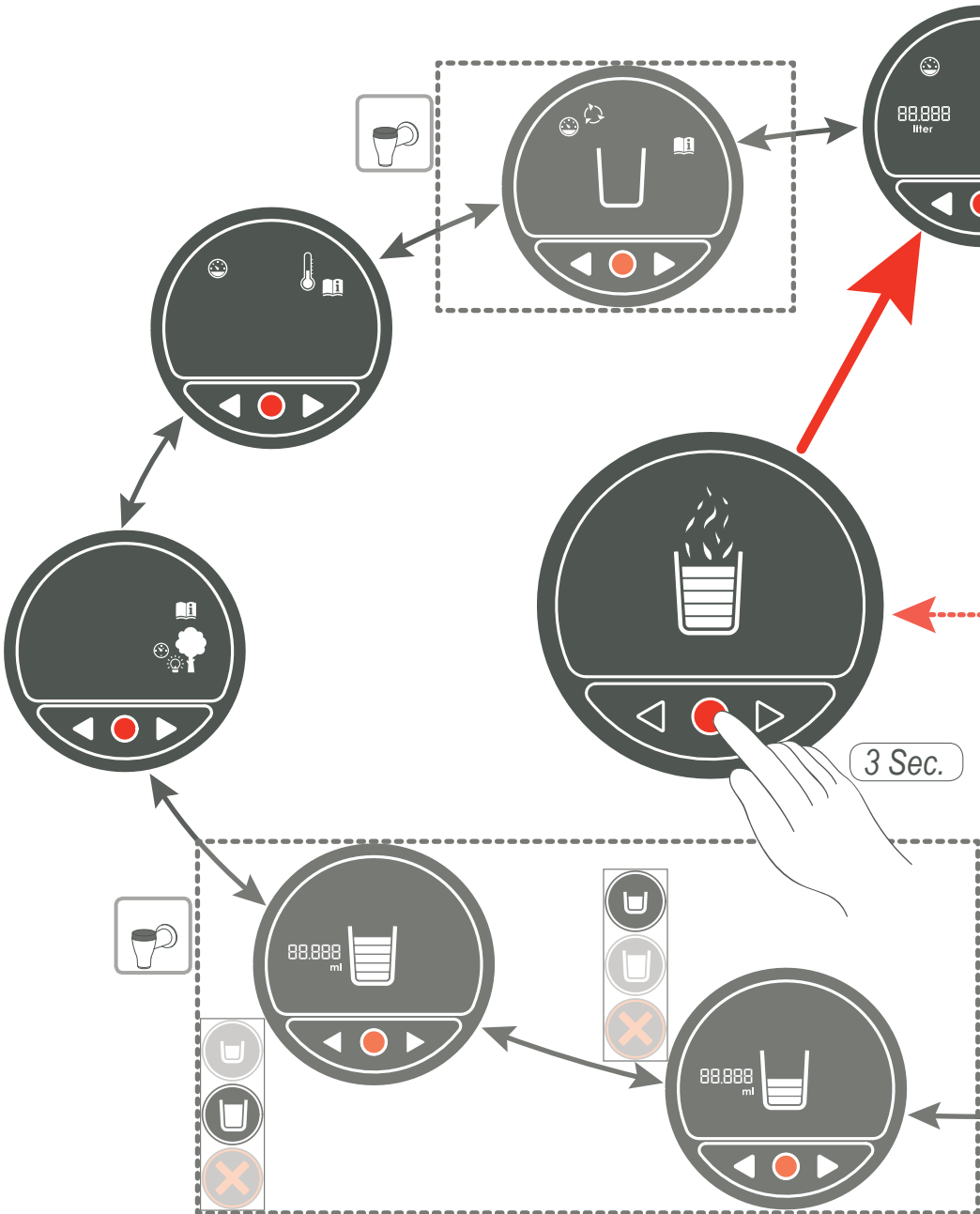

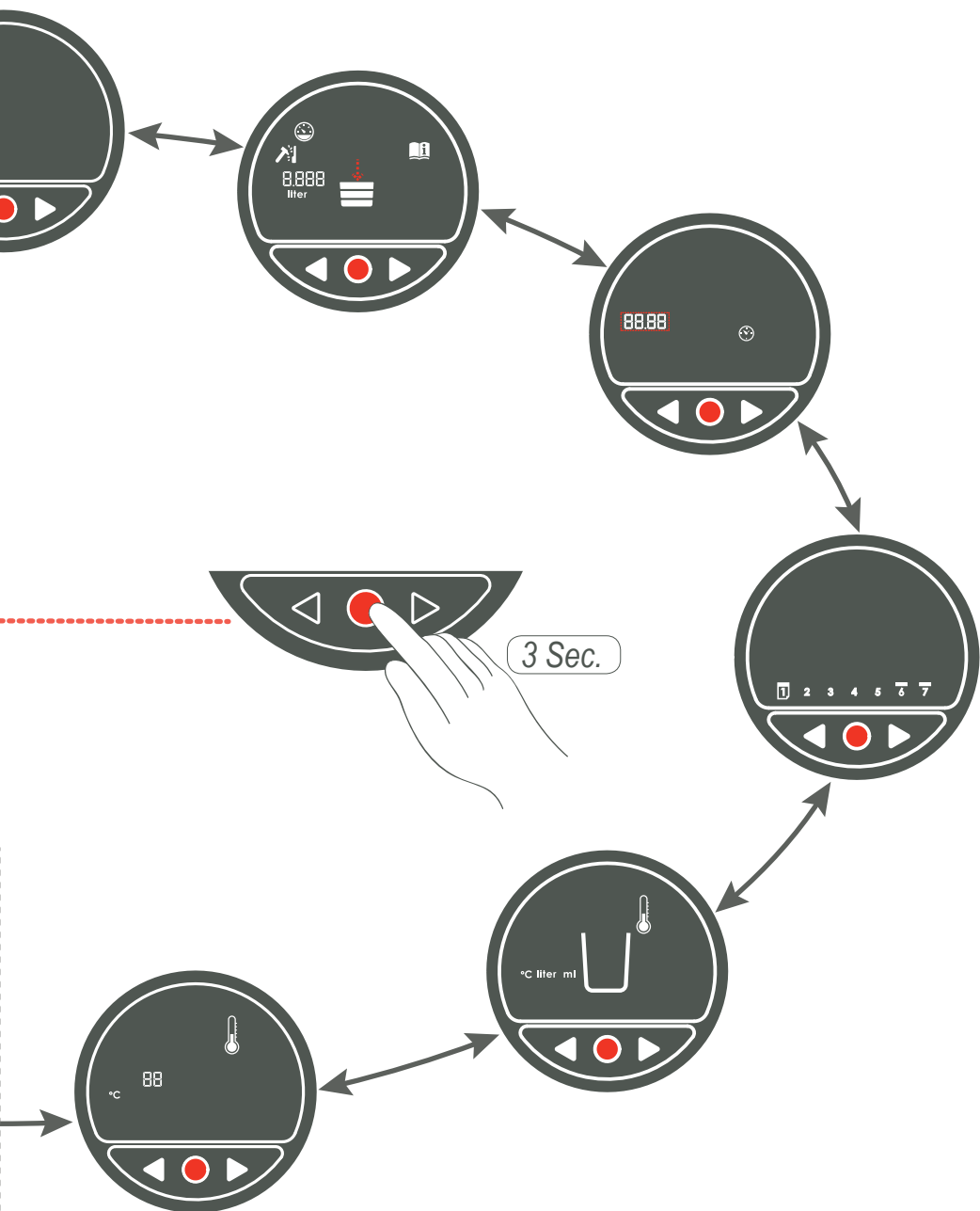



	☒	□	▲	■
English	Off	Minimum value	Standard value	Maximum value
Français	Eteint	Valeur minimum	Valeur standard	Valeur maximum
Deutsch	Aus	Minimum Wert	Standard Wert	Maximum Wert
Nederlands	Uit	Minimum waarde	Standaard waarde	Maximale waarde
Svenska	Av	Minimum värde	Standard värde	Maximalt värde
Norsk	Av	Minimum verdi	Standard verdi	Maksimum verdi
Dansk	Slukket	Minimum værdi	Standard værdi	Maksimum værdi
Suomi	Pois päältä	Minimi arvo	Oletusarvo	Maksimi arvo
Español	Apagado	Valor mínimo	Valor estándar	Valor máximo
Português	Desligado	Valor mínimo	Valor standard	Valor máximo
Italiano	Spento	Valore minimo	Valore standart	Valore massimo
Ελληνικά	Σβήνουν	Ελάχιστη τιμή	Αθέτηση	Ανώτατο όριο
Česky	Vypnutí	Minimální hodnota	Standard níhodnota	Maximální hodnota
Polski	Wyłączony	Minimalna wartość	Standardowa wartość	Maksymalna wartość
Română	Oprit	Valoare minimă	Valoare standard	Valoare maximă
Русский	Выключите	Минимальный значение	Значение по умолчанию	Максимальный значение
Türkçe	Kapalı	Minimum değer	Standart değer	Maksimum değer
中國語文	關閉	最低限度	默認	最大
日本語	オン	最小値	デフォルト	最大
한국어	끄고	최소값	디폴트 값	최대 값

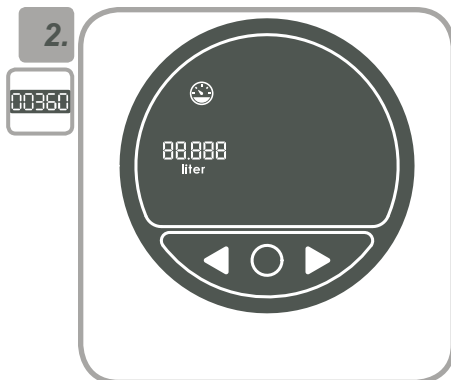
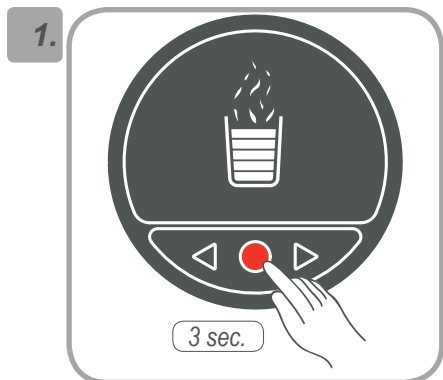

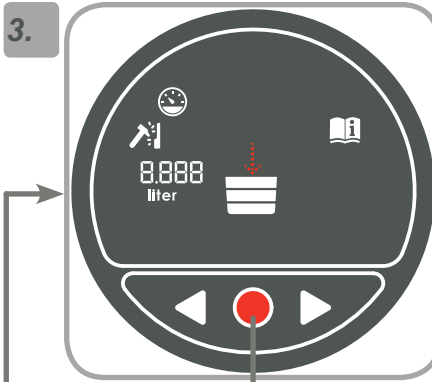

Maintenance counter (descaling / filter)
 Compteur d'entretien (détartrage / filtre)
 Wartungszähler (Entkalken / Filter)
 Onderhoudsteller (ontkalken / filter)
 Serviceräknenaren (avkalkning / filter)
 Vedlikeholdsteller (avkalkning / filter)
 Vedlikeholdelse tæller (afkalkning / filter)
 Huolto laskuri (kalkinpoisto / suodatin)
 El contador de mantenimiento (descalcificación / filtro)
 Contador de manutenção (descalcificação / filtro)
 Contatore di manutenzione (decalcificazione / filtro)
 Μετρητή συντήρησης (αφαλάτωσης / φίλτρο)
 Počítadlo údržby (odvápnění / filtr)
 Licznik konserwacji (usuwanie kamienia / filtr)
 Contor de întreținere (decalcifiere / filtru)
 Счетчик часов техобслуживания (удаление накипи / фильтр)
 Bakım sayacı (kirec çözücü / filtre)
 維護計數器 (除垢劑 / 過濾器)
 メンテナンスカウンタ (スケール除去 / フィルター)
 유지 보수 카운터 (스케일 제거 / 필터)

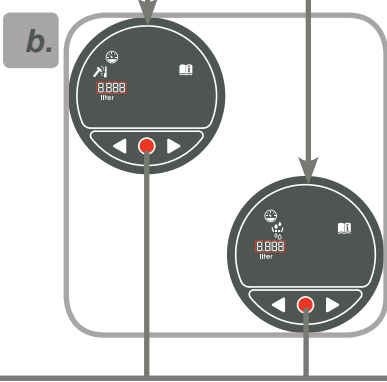
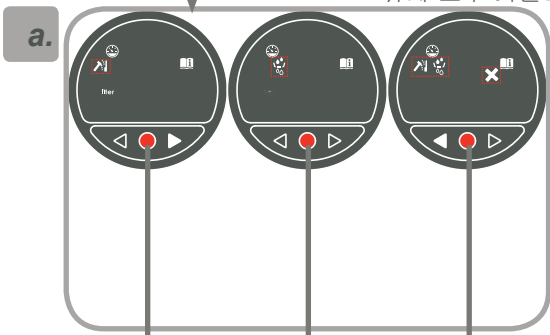

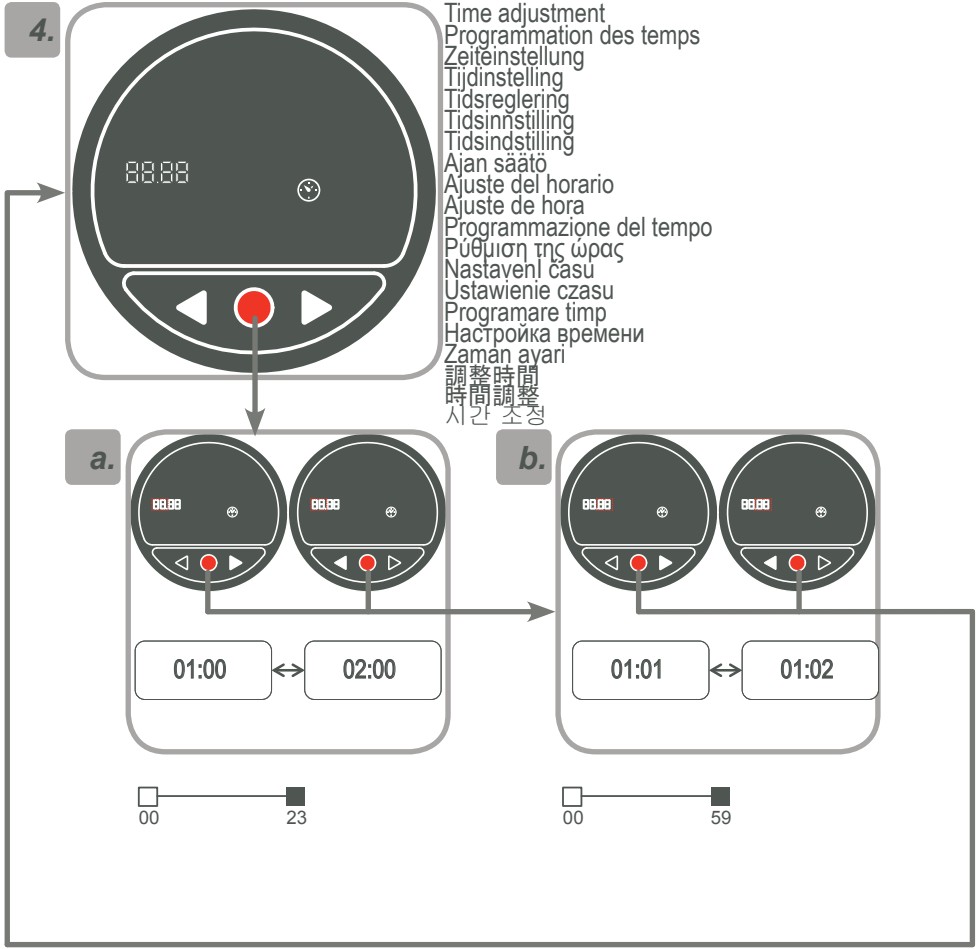

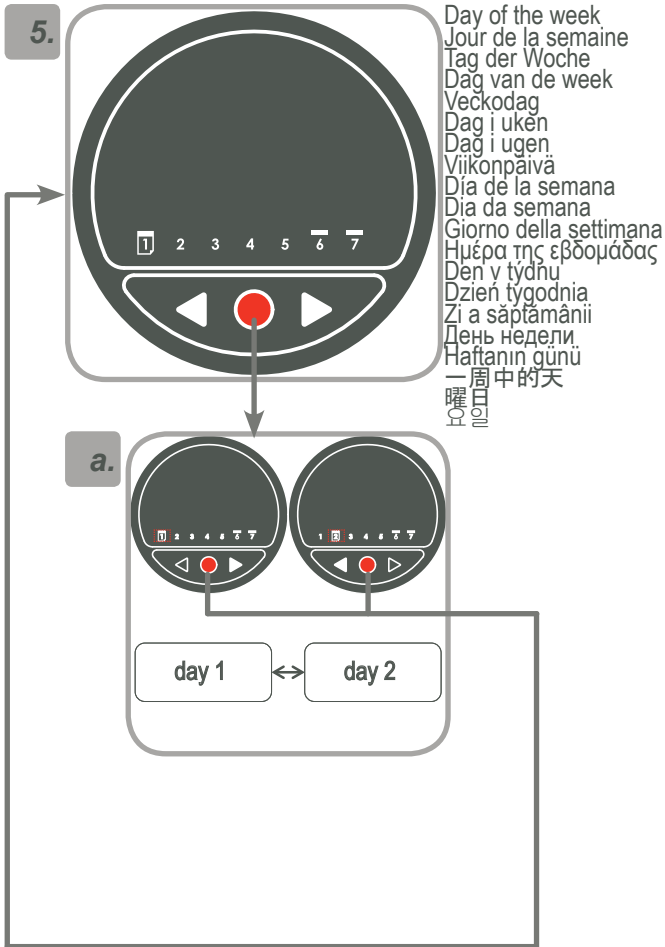

6.



Units
 Unités
 Einheiten
 Eenheden
 Enheter
 Enheter
 Enheder
 Yksiköt
 Unidades
 Unidades
 Unità
 Μονάδες
 Jednotky
 Jednostki
 Unitàti
 Единицы
 Birimler
 單位
 유닛
 단위

a.

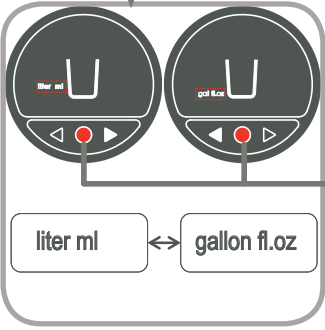

b.

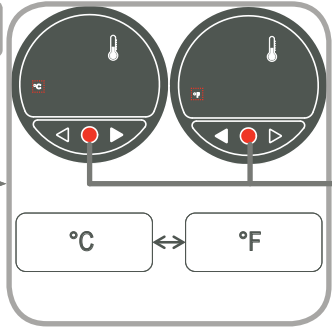

7.

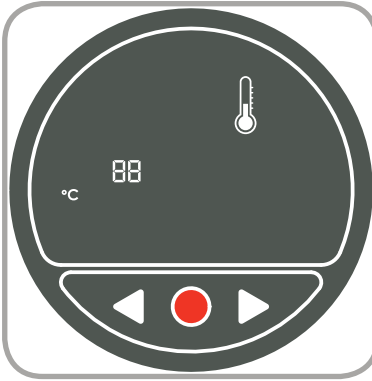

Boiler temperature
 Température chaudière
 Boiler Temperatur
 Boiler temperatuur
 Temperatur kokare
 Elementtemperatur
 Vand temperatur
 Säiliön lämpötila
 Temperatura de la resistencia
 Temperatura da caldeira
 Temperatura boiler
 θερμοκρασία του λέβητα
 Toplota boileru
 Temperatura bojlera
 Temperaturá boiler
 Температура котла
 Boyler derecesi
 鍋爐溫度
 ボイラー温度
 보일러 온도

a.

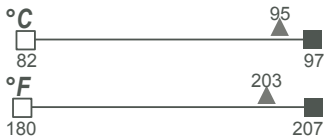
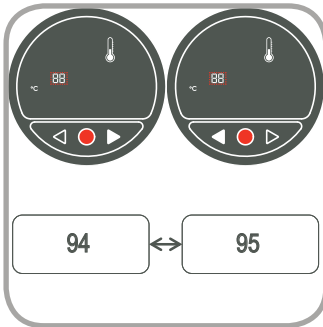

8. 



Amount of hot water
 Quantité d'eau chaude
 Füllmenge Heißwasser
 Doseergrooite heet water
 Kvantitet hetvatten
 Mengde varmt vann
 Mængde af varmt vand
 Kuuman veden määrä
 Dosificación grandezade agua caliente
 Quantidade de água quente
 Quantità acqua calda
 Χωρητικότητα φλιτζάνι ζεστό νερό
 Množství horké vody
 Ilość wody gorącej
 Cantitatea apă fierbinte
 Количество горячей воды
 İçin sıcak su miktarı
 容量一杯熱水
 お湯の容量カップ
 뜨거운 물 용량 컵

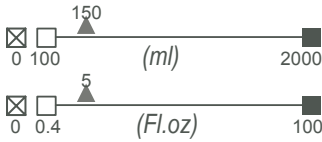
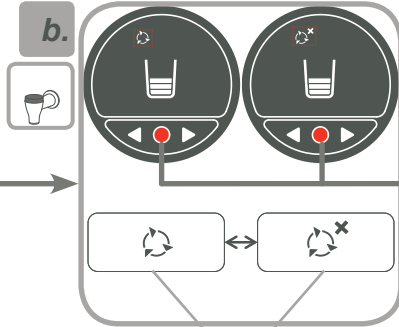
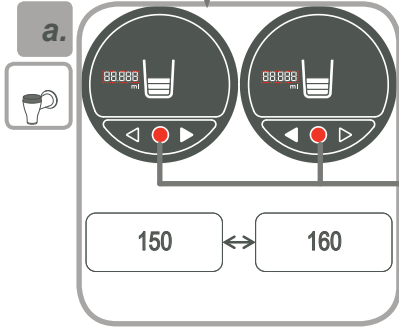

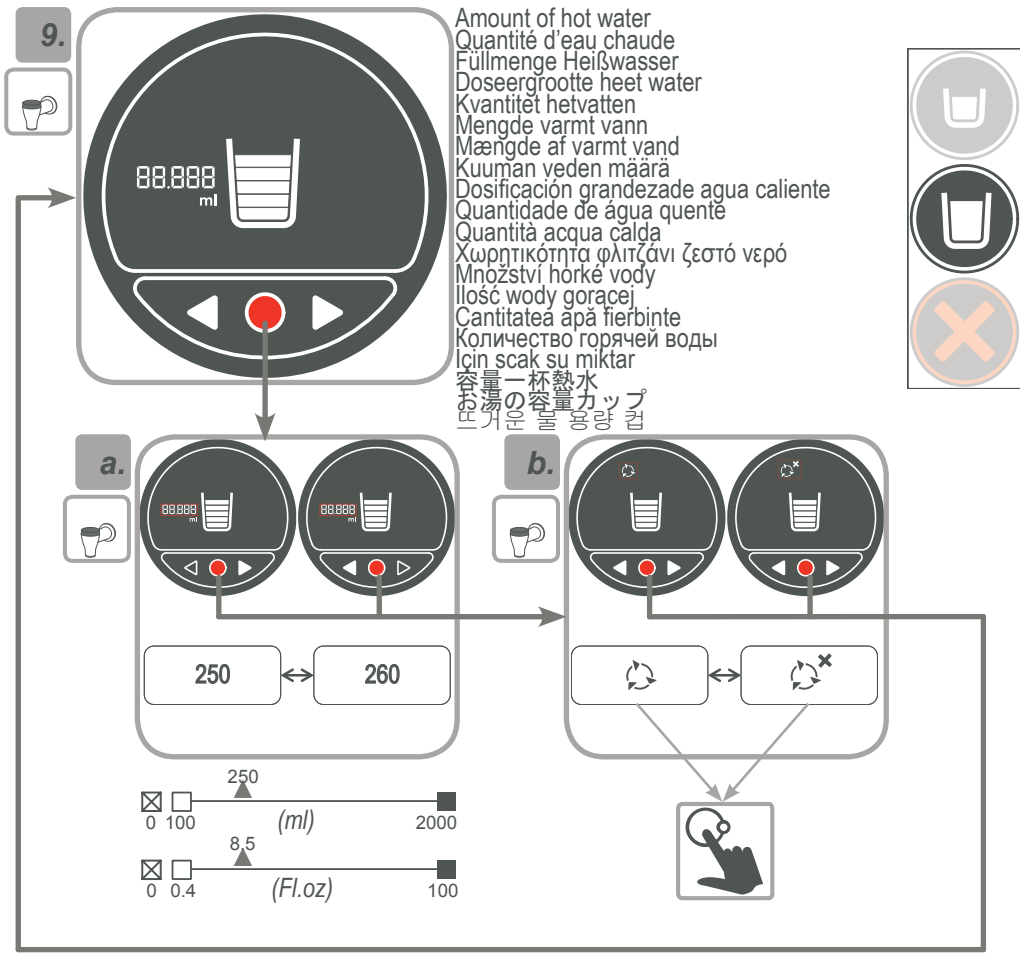

10.

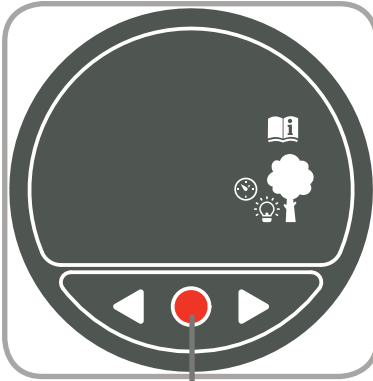

Energy-saving mode
 Mode économique
 Energiesparstufe
 Energie spaarstand
 Energisparläge
 Energisparingsmodus
 Energi spare funktion
 Sähköä säästävää malli
 Posición de economía
 Economizador de energia
 Risparmio energia
 Λειτουργία εξοικονόμησης ενέργειας
 Ochrona energii
 Tryb pracy "eco" oszczędzający energię
 Mod economic
 Энергосберегающий режим
 Energi tassarufu modu
 節能模式
 省工省电 모드
 에너지 절약 모드

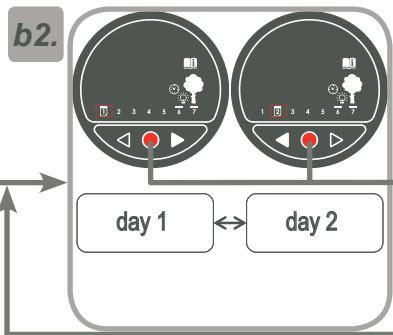
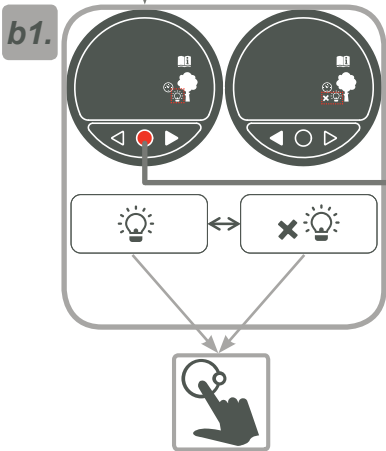
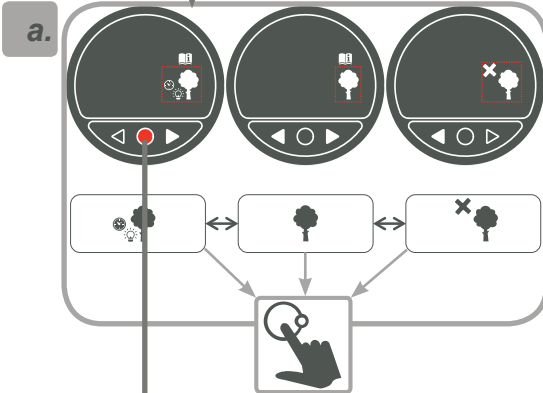

c1.



End time energy-saving mode / start normal operation
 Mode économique heure de fin / début du fonctionnement normal
 Endzeit Energiesparstufe / Start Normalbetrieb
 Eind tijd energie spaarstand / start normale werking
 Sluttid energisparläge / starta normal drift
 Sluttid energisparingsmodus / starte normal drift
 Sluttidspunkt energi spare funktion / start normal drift
 Loppuaika sähköä säästävä malli / aloita normaalia toimintaa
 Hora de fin posición de economía / iniciar la operación normal
 Fim do tempo economizador de energia / iniciar a operação normal
 Fine del tempo risparmio energia / inizia il normale funzionamento
 Ώρα λήξης λειτουργία εξοικονόμησης ενέργειας/έναρξη κανονικής λειτουργίας
 Konec času ochrana energie / spustit normalni provoz
 Czas koniec oszczędzający energię / rozpoczęcia normalnej pracy
 Ora de terminare mod economic / porniti de operării normale
 Время окончания режима эко / начать нормальной работы
 Bitiş zamanı enerji tasarrufu modu / normal çalışma başla
 結束時間節能模式 / 開始正常運行
 終了時間節約モード / 通常動作開始
 종료 시간 절약 모드 / 정상 동작의 시작하다

c2.



Start time energy-saving mode / end normal operation
 Mode économique heure de début / fin du fonctionnement normal
 Startzeit Energiesparstufe / Ende Normalbetrieb
 Starttijd energie spaarstand / einde normale werking
 Starttid energisparläge / slut på normal drift
 Starttid energisparingsmodus / slutt på normal drift
 Starttidspunkt energi spare funktion / efter normal normal drift
 Alkuu aika sähköä säästävä malli / lopussa normaalia toimintaa
 Hora de inicio posición de economía / fin de la operación normal
 Tempo de inicio economizador de energia / fim de operação normal
 Ora di inizio risparmio energia / fin di normale funzionamento
 Ώρα έναρξης λειτουργία εξοικονόμησης ενέργειας/τέλος της κανονικής λειτουργίας
 Počáteční čas ochrana energie / konec normalni provoz
 Czas rozpoczęcia oszczędzający energię/zakończenie normalnej pracy
 Ora de pornire mod economic / sfârșitul de operării normale
 Время начала режима эко / конец нормальной работу
 Başlama zamanı enerji tasarrufu modu / normal çalışma sonu
 開始時間節能模式 / 結束正常運行
 開始時刻モード / 通常動作終了節約
 시작 시간 절약 모드 / 정상 동작의 종료

c3.



Energy-saving mode (pre-eco time)
 Mode économique (temps de pré-éco)
 Energiesparstufe (pre-eco Zeit)
 Energie spaarstand (pre-eco tijd)
 Energisparläge (pre-eko tid)
 Energisparingsmodus (pre-eco tid)
 Energi spare funktion (pre-eco tid)
 Sähköä säästävä malli (pre-eco aika)
 Posición de economía (tempo de pre-eco)
 Economizador de energia (tempo de pré-eco)
 Risparmio energia (tempo di pre-eco)
 Λειτουργία εξοικονόμησης ενέργειας (χρόνος pre-eco)
 Ochrana energie (předběžné-eko čas)
 Tryb pracy "eco" oszczędzający energię (czas pre-eko)
 Mod economic (timep de pre-eco)
 Энергосберегающий режим (предварительно эко раз)
 Enerji tasarrufu modu (pre-eko zamanı)
 節能模式 (預生能時間)
 省エネモードを (プレエコ時間)
 에너지 절약 모드 (프리 에코 시간)

11.

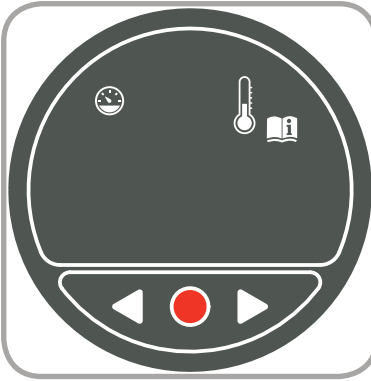

Boiling Temperature Determination Routine (BTDR) p. 49
 Programme de détermination du point d'ébullition p. 49
 Siedepunktermittlungsprogramm Seite 49
 Kookpunt bepaal programma blz. 49
 Program för fastställning av kokpunkt sid. 49
 Program for automatisk fastsettelse av kokepunktet s. 49
 Kogepunktet bestemmelse routine s. 49
 Kiehumispiste määrittäminen rutiinimaineen s. 49
 Rutina determinación de la temperatura de ebullición p. 49
 Rotina de determinar a temperatura de ebulição p. 49
 Routine di determinazione della temperatura di ebollizione p. 49
 Ρουτίνα προσδιορισμού της θερμοκρασίας βρασμού p. 49
 Teplota varu stanovení rutini s. 49
 Program okrelenia punktu wrzenia p. 49
 Punct de fierbere determinarea temperaturii de rutina p. 49
 Кипение регулярное определение температуры p. 49
 Καυπάνα σιcakliqi belirlemesi rutin p. 49

沸騰温度判定程序
 沸騰温度判定ルーチン
 끓는 온도 판정 루틴

页 P. 49
 페이치. 49

12.



Volume calibration p. 53
 Calibrage de volume p. 53
 Volumenkalibrierung Seite 53
 Volume kalibratie blz. 53
 Volym kalibrering sid. 53
 Volumkalibrering s. 53
 Kalibrering volumen s. 53
 Tilavuuskalibrointi s. 53
 Calibración del volumen p. 53
 Calibragem de volume p. 53
 Calibratura del volume p. 53
 Βαθμονόμησης όγκος σ. 53
 Kalibrace volume s. 53
 kalibracija glosności p. 53
 Calibrare volum p. 53
 Калибровка объем p. 53
 Hacim kalibrasyonu p. 53

體積校準
 体積較正
 볼륨 교정

页 P. 53
 페이치. 53

13.



14.





Descaling
Détartrage
Entkalkung
Ontkalken
Avkalkning

Rensing
Afkalkning
Kalkinpoisto
Descalcificación
Descalcificação

Decalcificazione
Αφαιλάτωση
Odvárňení
Odkamienanie
Decalcarizare

Декальцификация
Kireçten arındırma
除垢
スケール除去
물때를 제거

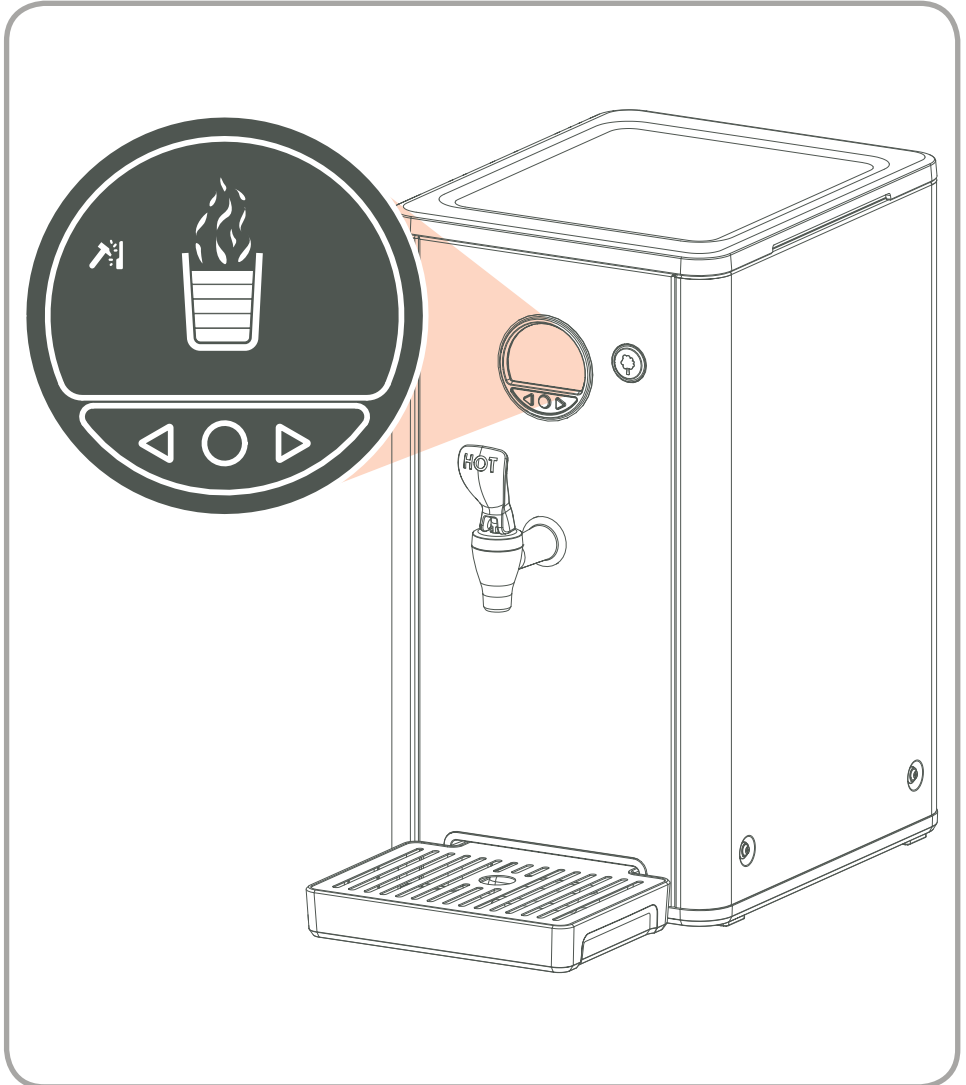

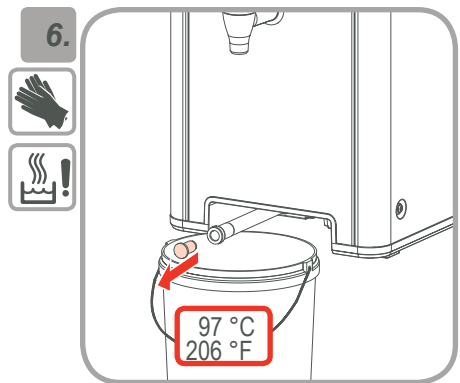
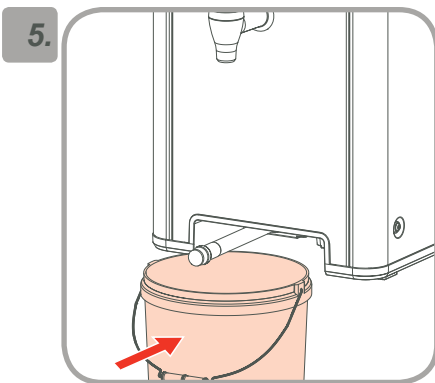
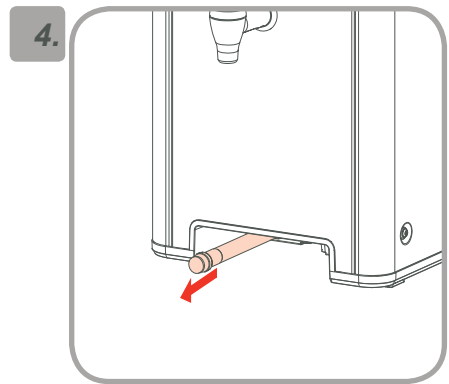
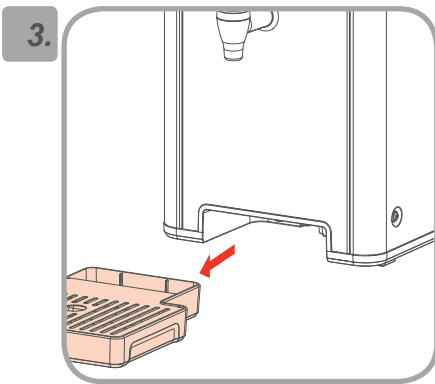
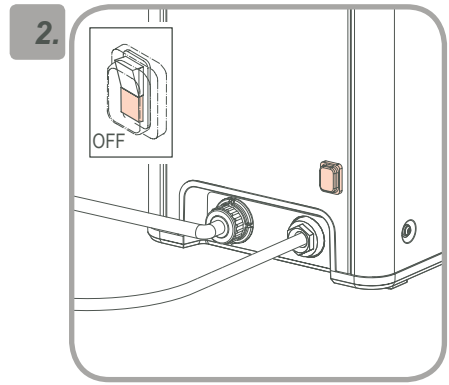
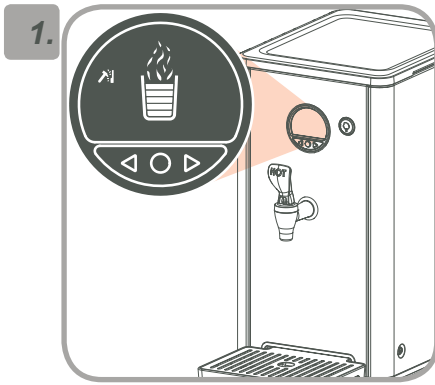



7.

HWA 6(D)	6 L.
HWA 14(D)	14 L.
HWA 4(D)	475 fl.oz
HWA 21	21 L.
HWA 5	710 fl.oz

8.

9.

10.

11.

12.

HWA 6(D)	HWA 14(D)	200 g / 7 oz 2.0 L. / 68 fl oz 60 °C / 140 °F
100 g	HWA 4(D)	
1.0 L.	HWA 21	
60 °C	HWA 5	



13.

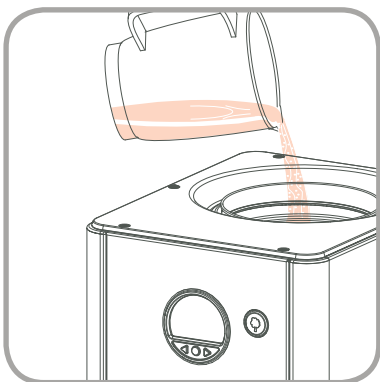

14.



3 Min.



15.



16.

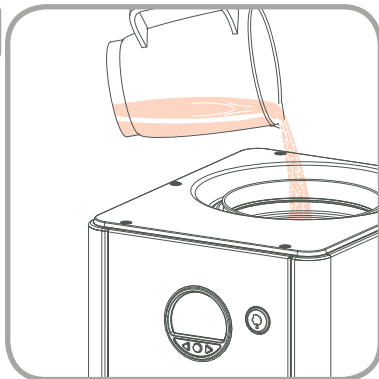

17.

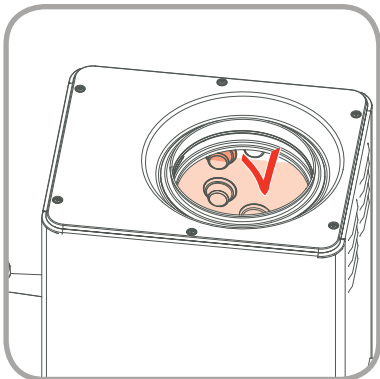

18.

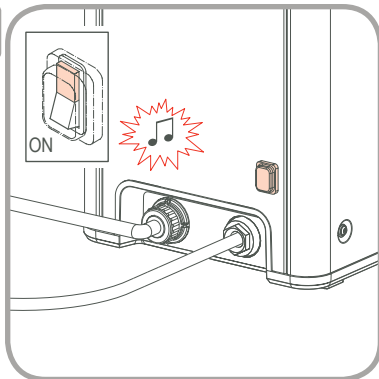

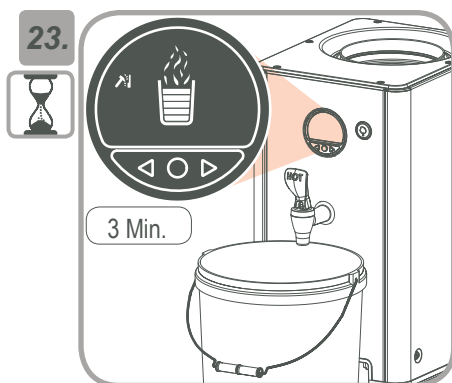
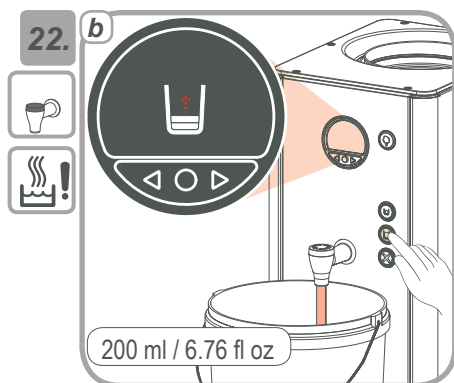
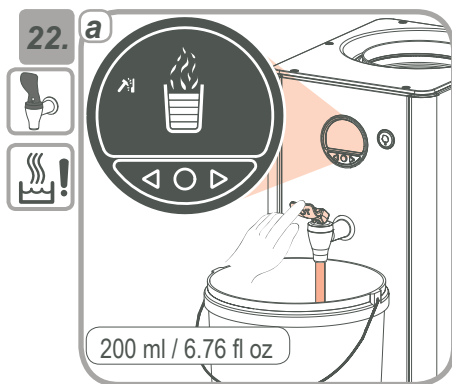
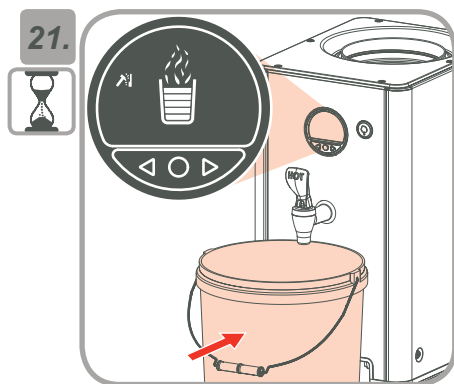
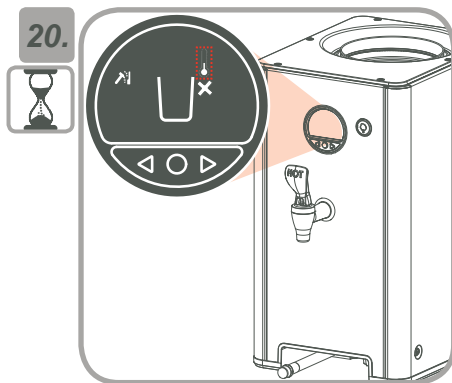
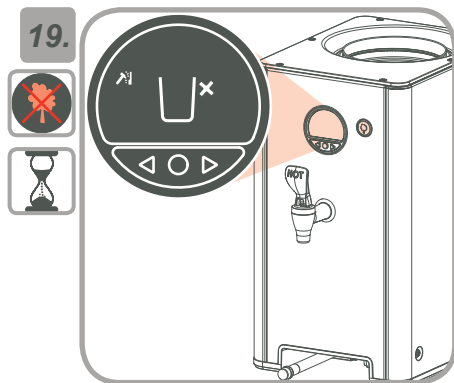

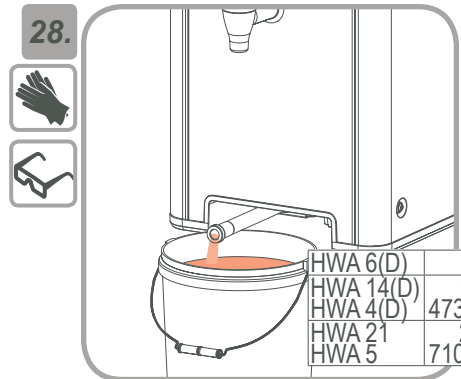
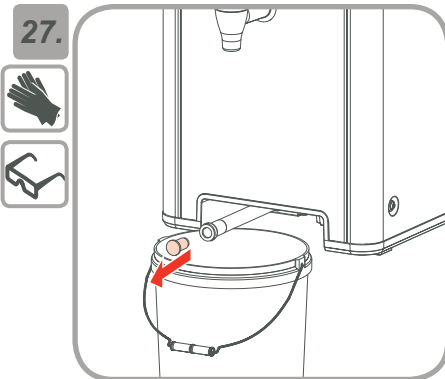
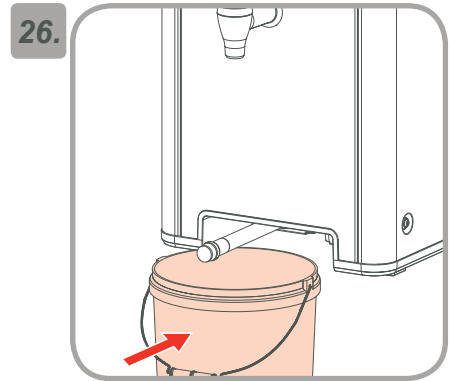
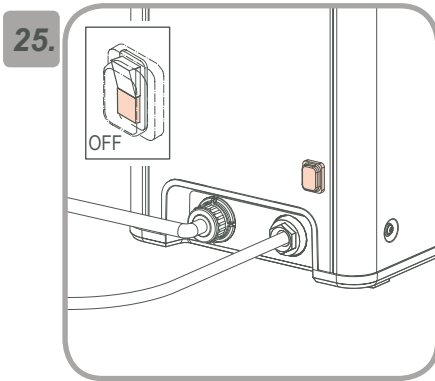
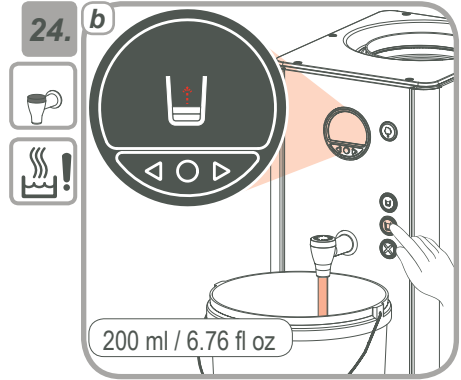
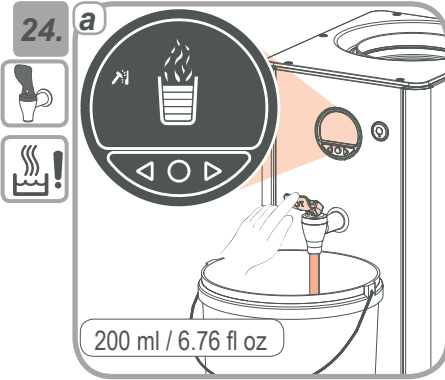



29.



30.

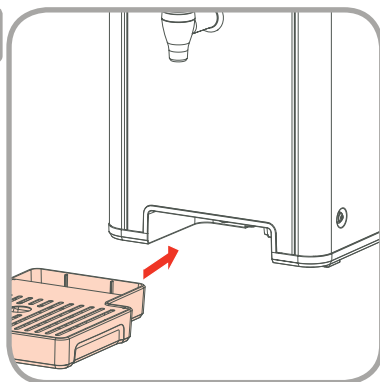

31.



32.

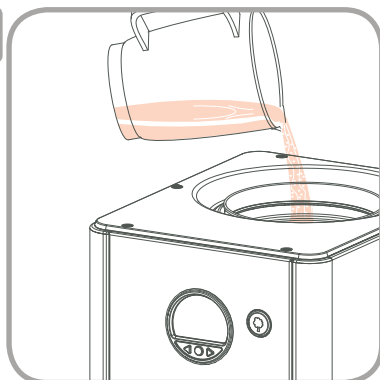

33.

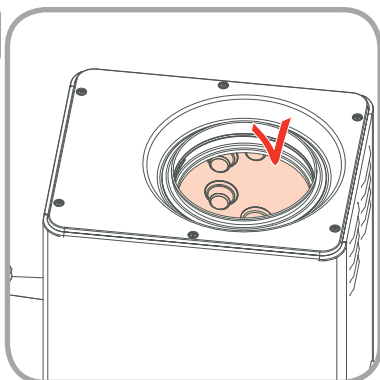

34.

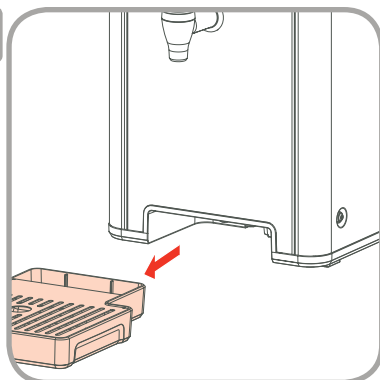



35.

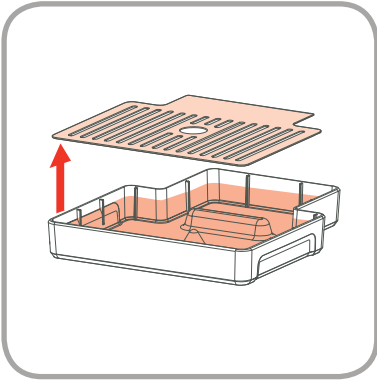

36.

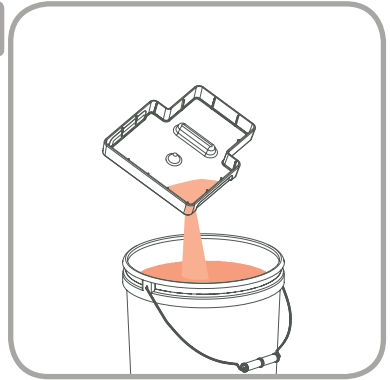

37.

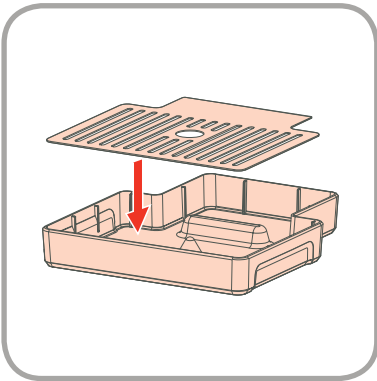

38.

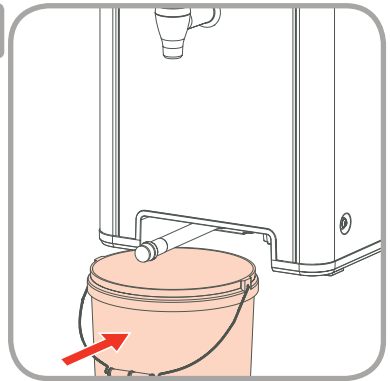

39.



40.

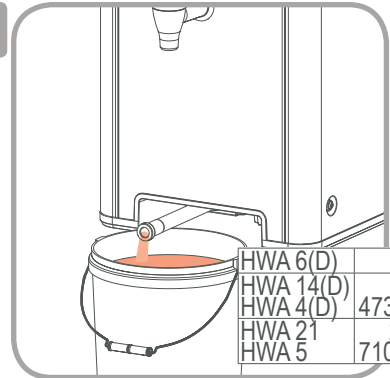

HWA 6(D)	6	L.
HWA 14(D)	14	L.
HWA 4(D)	473.4	fl.oz
HWA 21	21	L.
HWA 5	710.1	fl.oz



41.

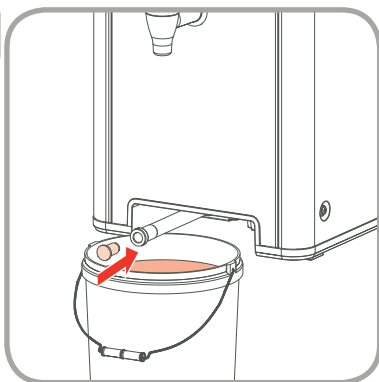

42.

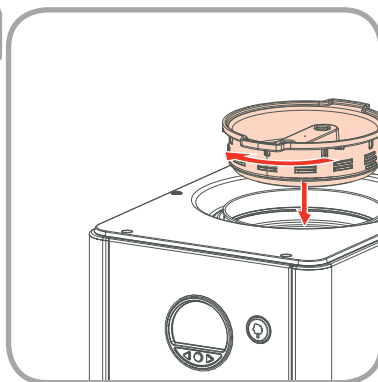

43.

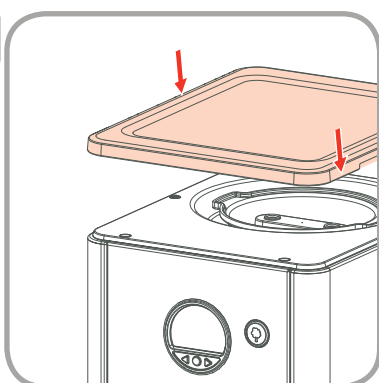

44.

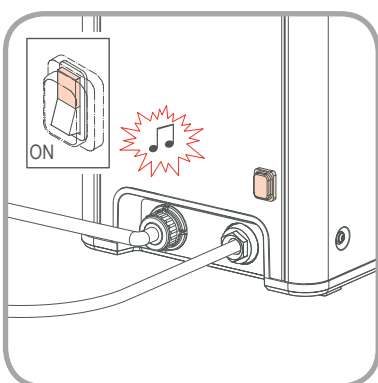

45.

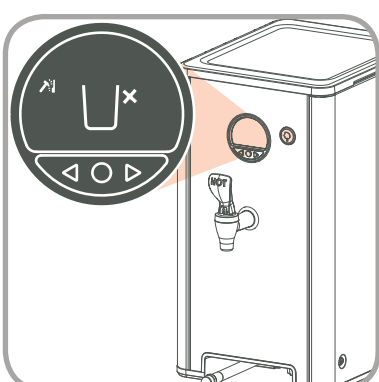

46.

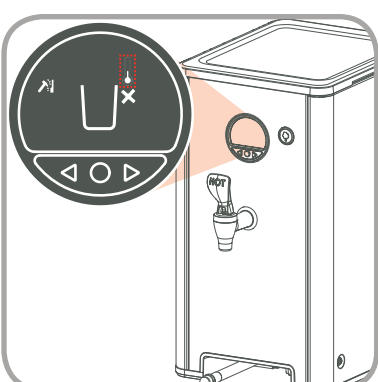

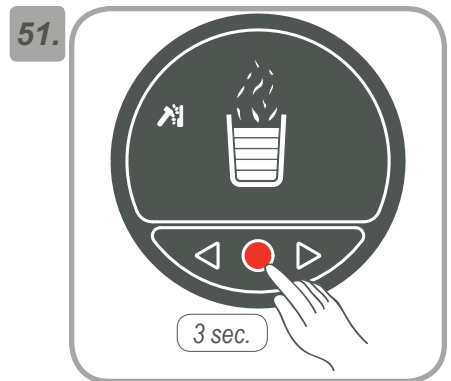
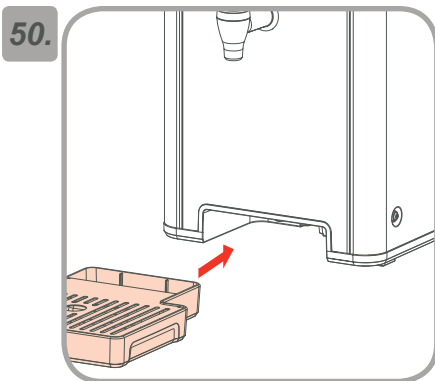
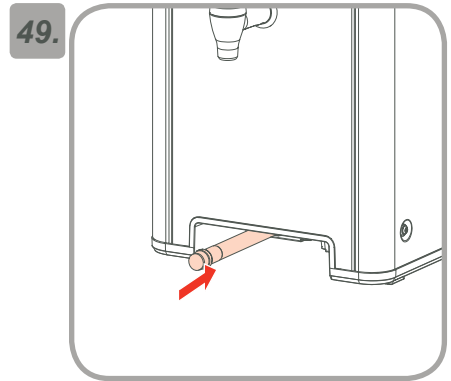
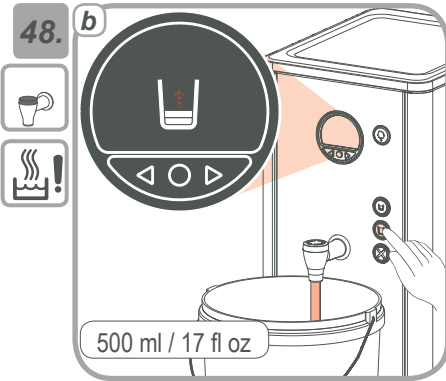
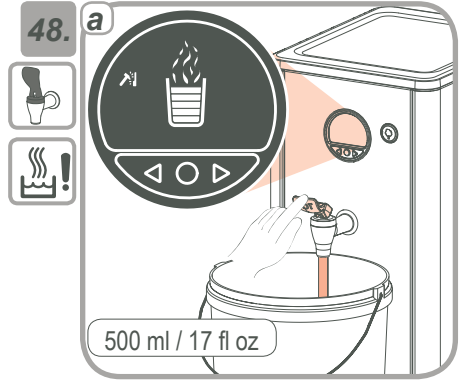
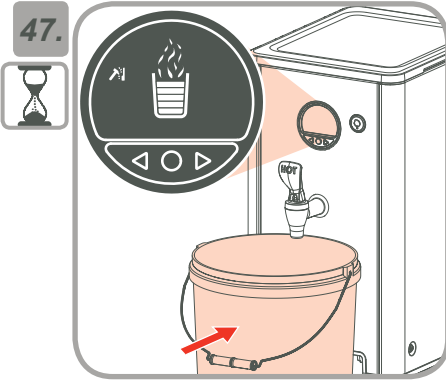

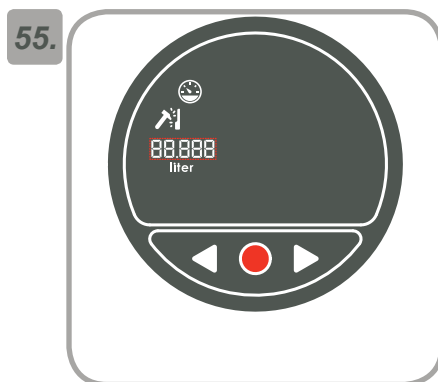
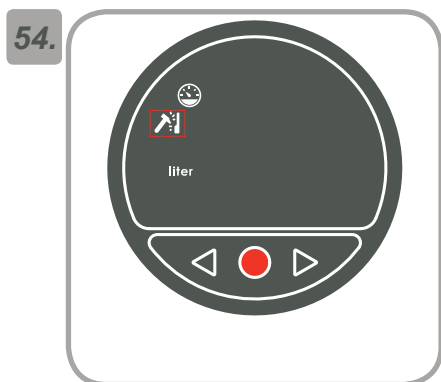
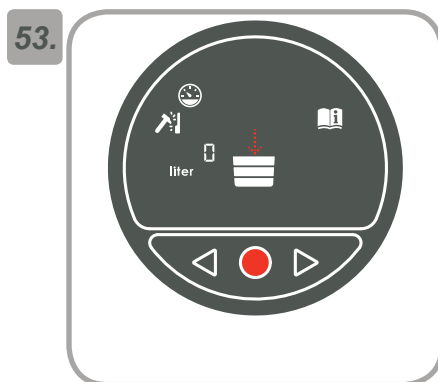
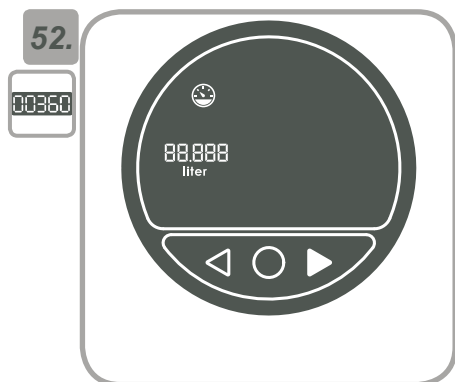

	L.	Gal.	°DH	°TH	ppm	mmol
☒	0	0				
□	200	50	18 - 30 =	32 - 55 =	240 - 500	1.0 °DH = 0.179 mmol/l = 6.052 mmol/fl.oz
	500	125	12 - 18 =	22 - 32 =	180 - 240	
▲	1000	250	8 - 12 =	15 - 22 =	120 - 180	1.0 °TH = 0.100 mmol/l = 3.381 mmol/fl.oz
	1500	375	4 - 8 =	7 - 15 =	60 - 120	
■	2000	500	0 - 4 =	0 - 7 =	0 - 60	1.0 ppm = 0.010 mmol/l = 0.338 mmol/fl.oz



56.

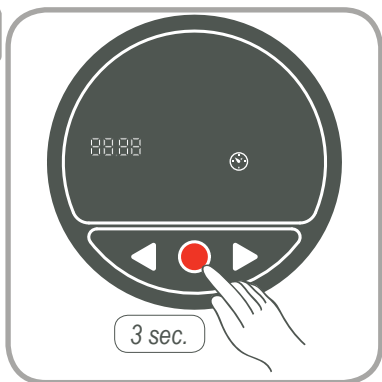

57.



Determine boiling point	Fastsettelse av kokepunktet	Temperatura di ebollizione	Кипение определение
Déterminer d'ébullition	Kogepunktet bestemmelse	Θερμοκρασία βρασμού	Καύματα noktasi tayini
Siedepunktermittlung	Kiehumispiste määrittäminen	Bod varu stanovení	確定沸點
Kookpunt bepalen	Temperatura de ebullición	Określenie punktu wrzenia	沸点を決定します
Fastställning av kokpunkt	Temperatura de ebulição	Determinarea fierbere	비점 결정

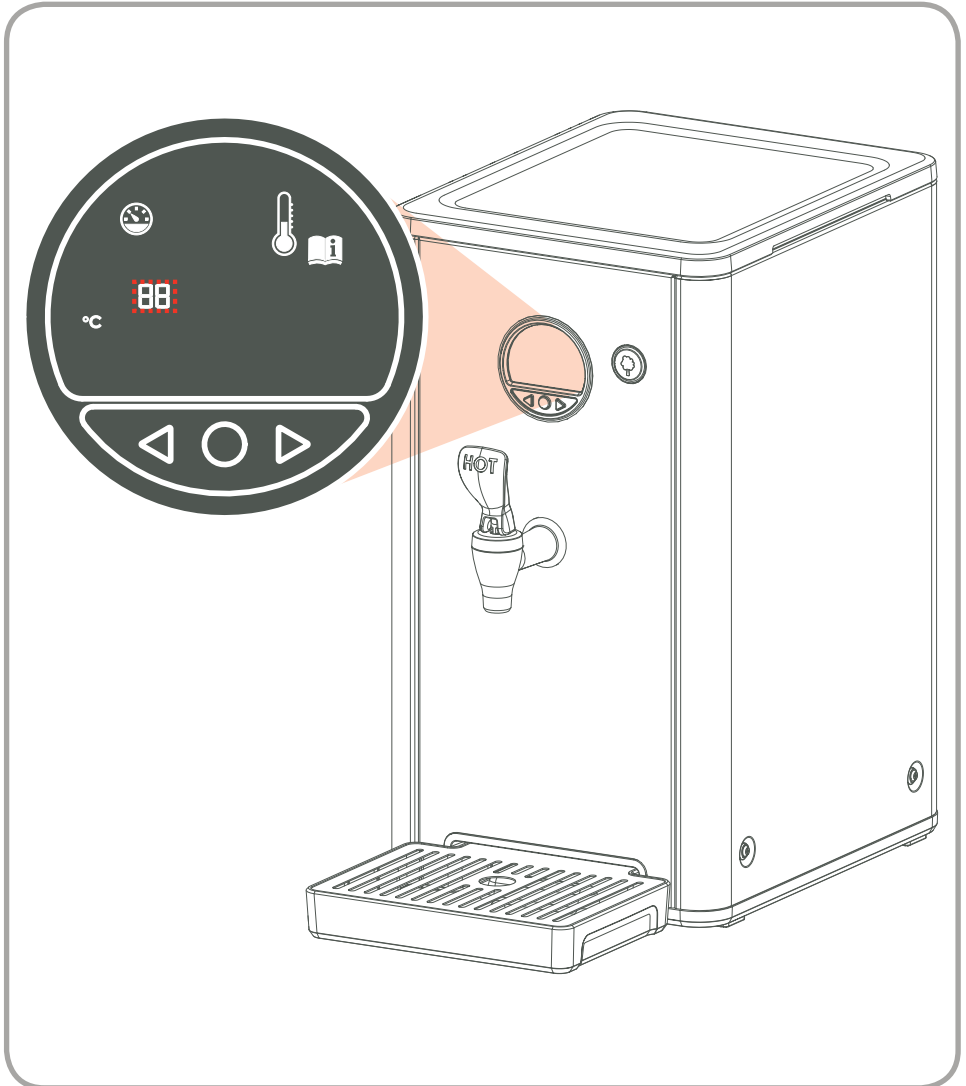

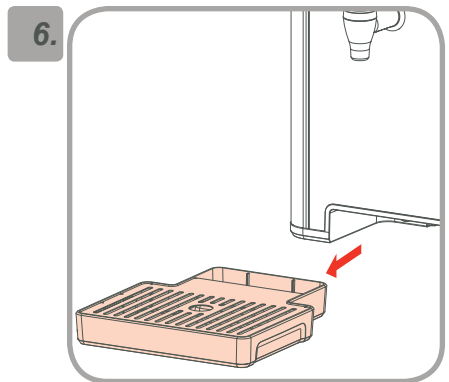
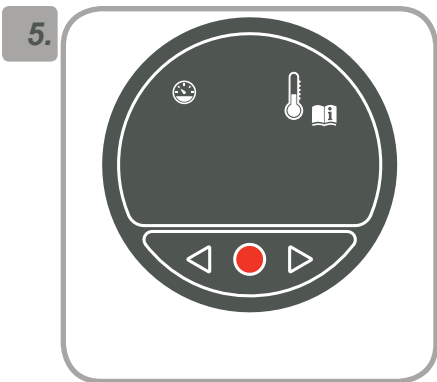
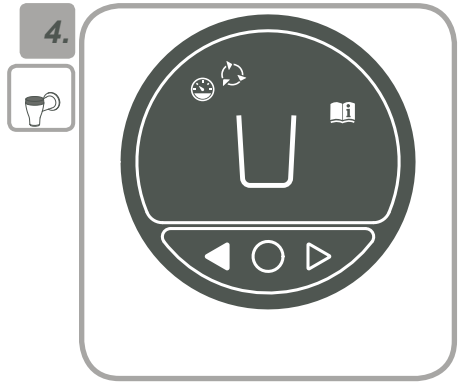
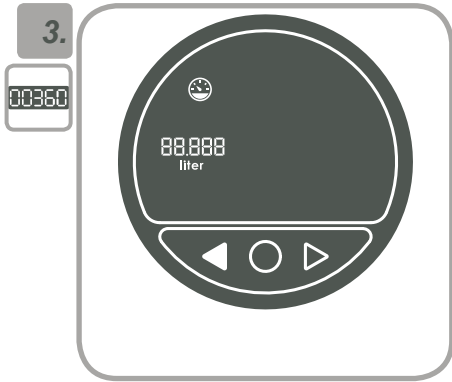
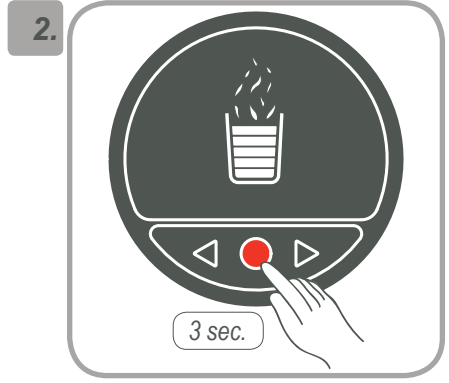
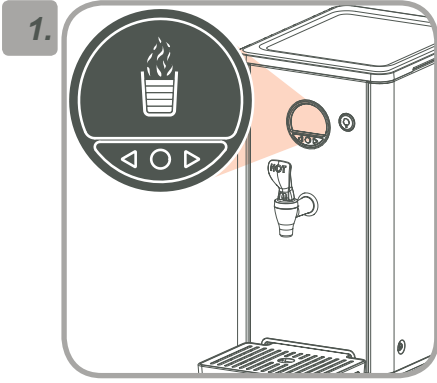

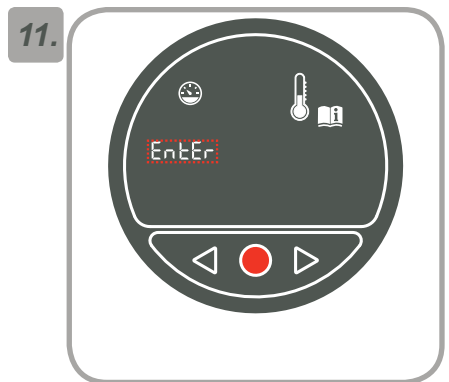
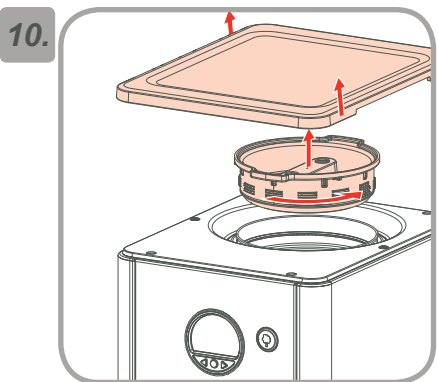
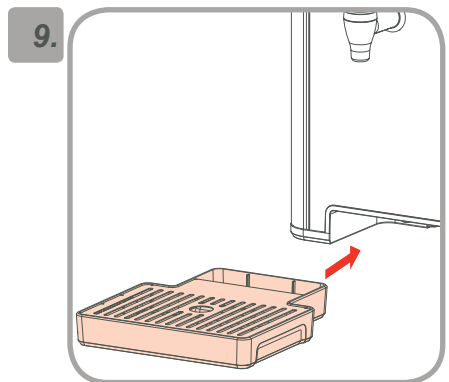
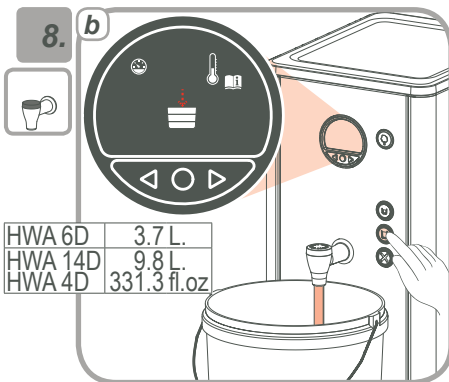
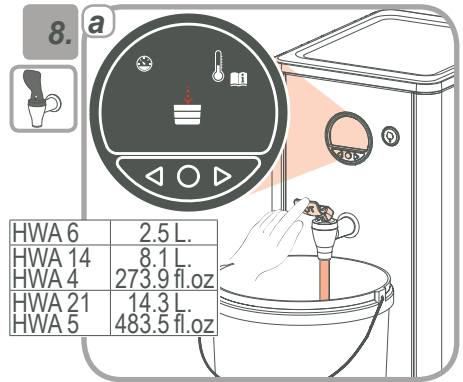
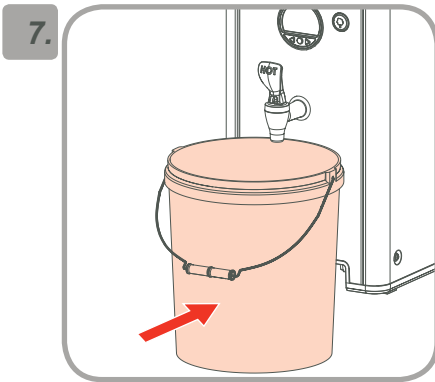

12.



13.

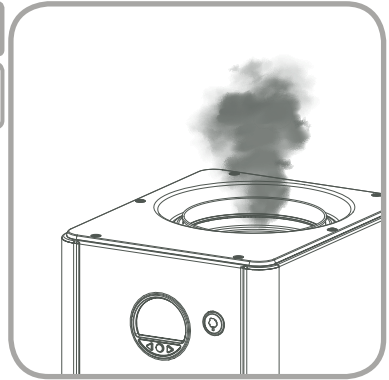

14.



15.

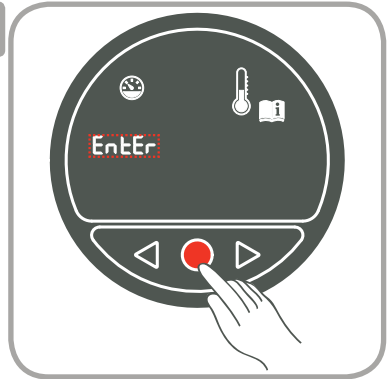

16.

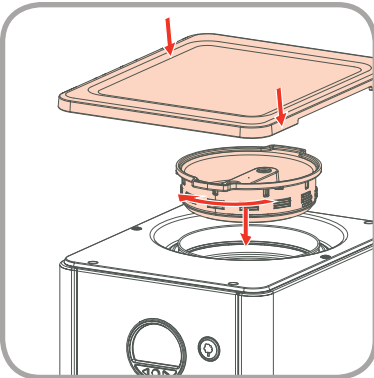

17.



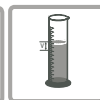

Calibrating volume
Calibrage quantité
Kalibrierung Menge
Kalibrenen volume
Kalibrering volym

Kalibrere volum
Kalibrering volumen
Vesimäärä kalibrointi
Calibración del volumen
Calibração do volume

Calibrazione del volume
Βαθμονόμηση του όγκου
Kalibrace objemu
Kalibracja objętości
Calibreaa volumul

Калибровка объема
Nacmi kalibre etme
校準水量
水量の較正
물의 양을 교정

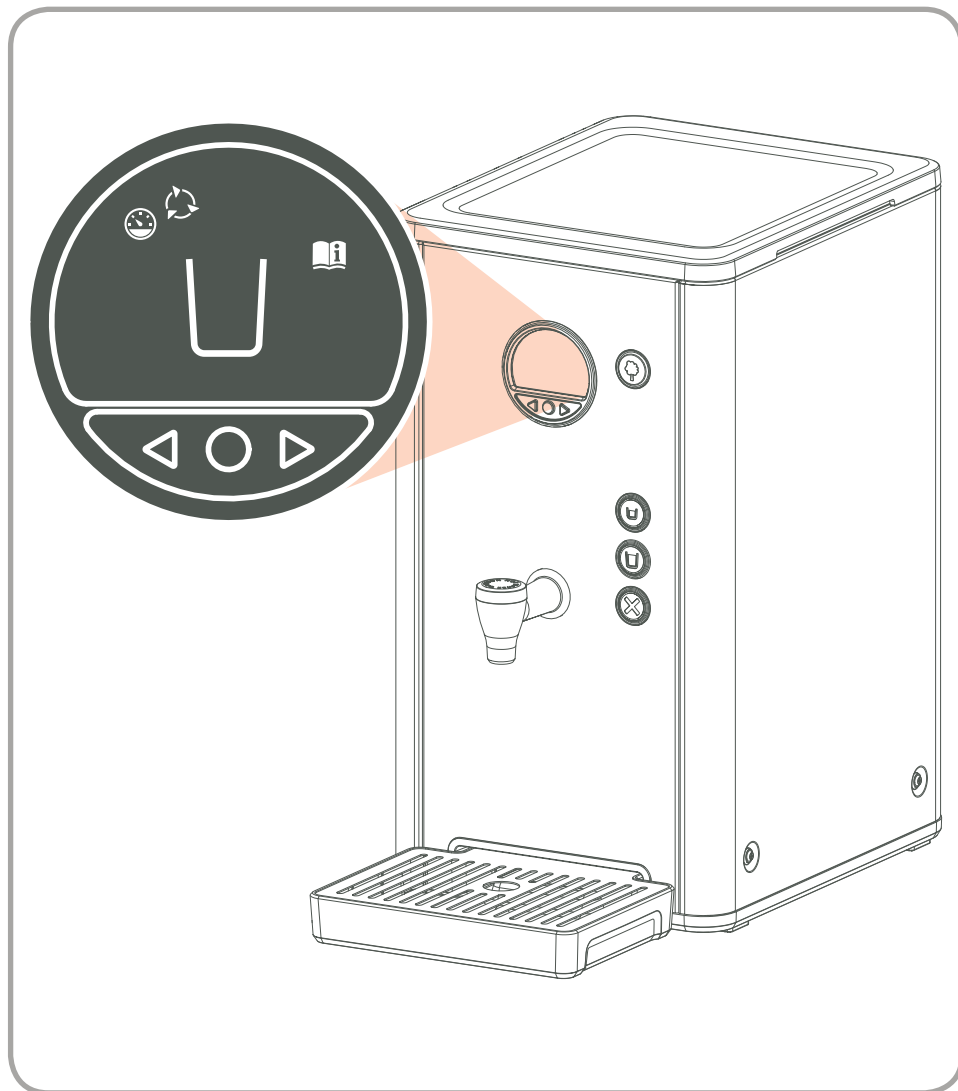

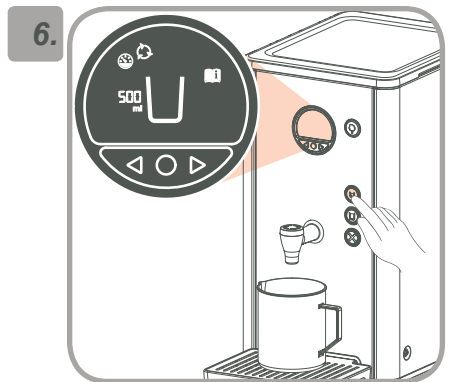
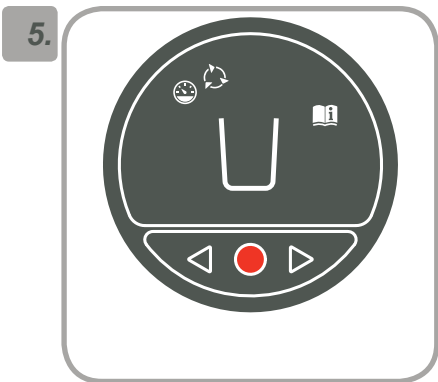
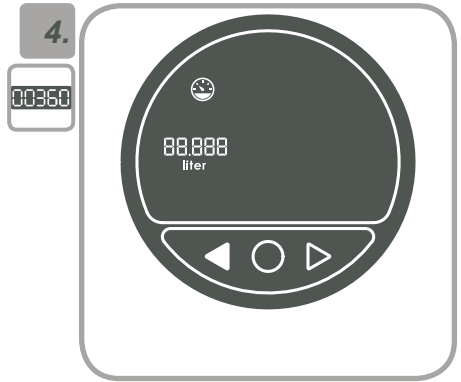
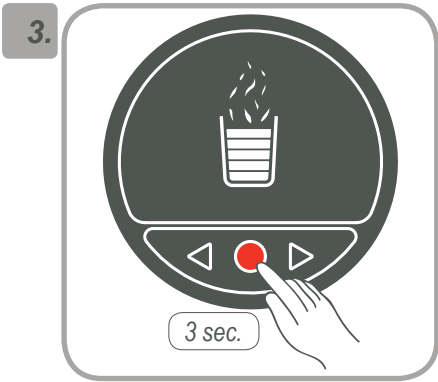
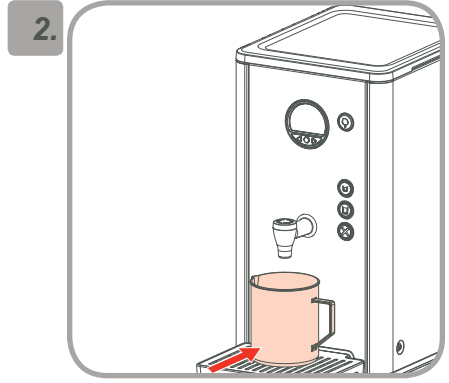
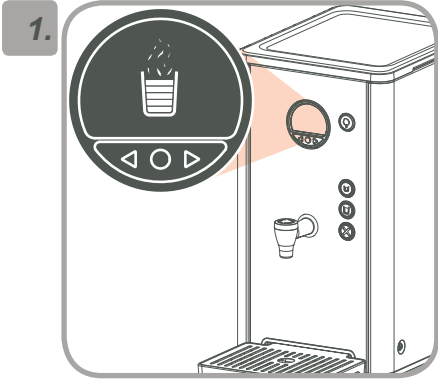

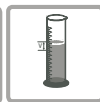

7.

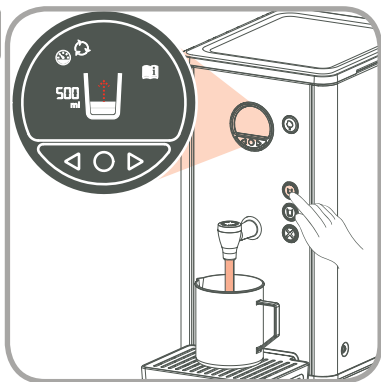

8.

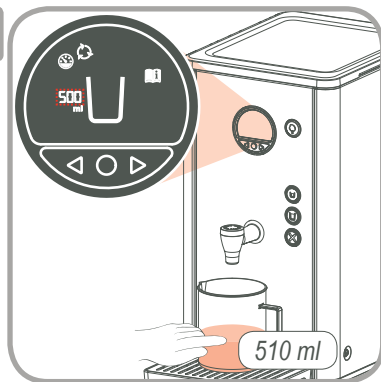

9.

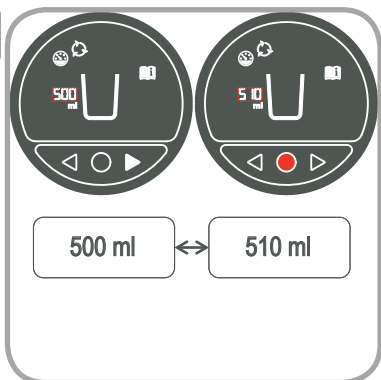

10.

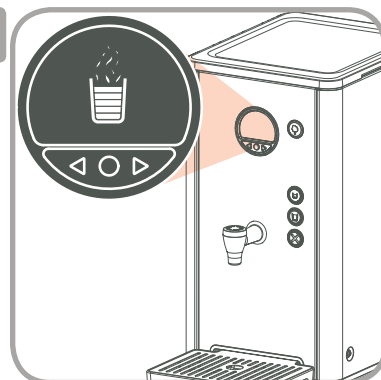



Moving
Déménagement
Versetzen
Verplaatsen
Flytta

Flytte
Flytning
Liikkua
Mover
Mover

Spostare
Μετακινήσετε
Přemísovat
Przenosić
Mutare

Перемещение
Hareket ettirmek
移動機
の動き
기계를 이동

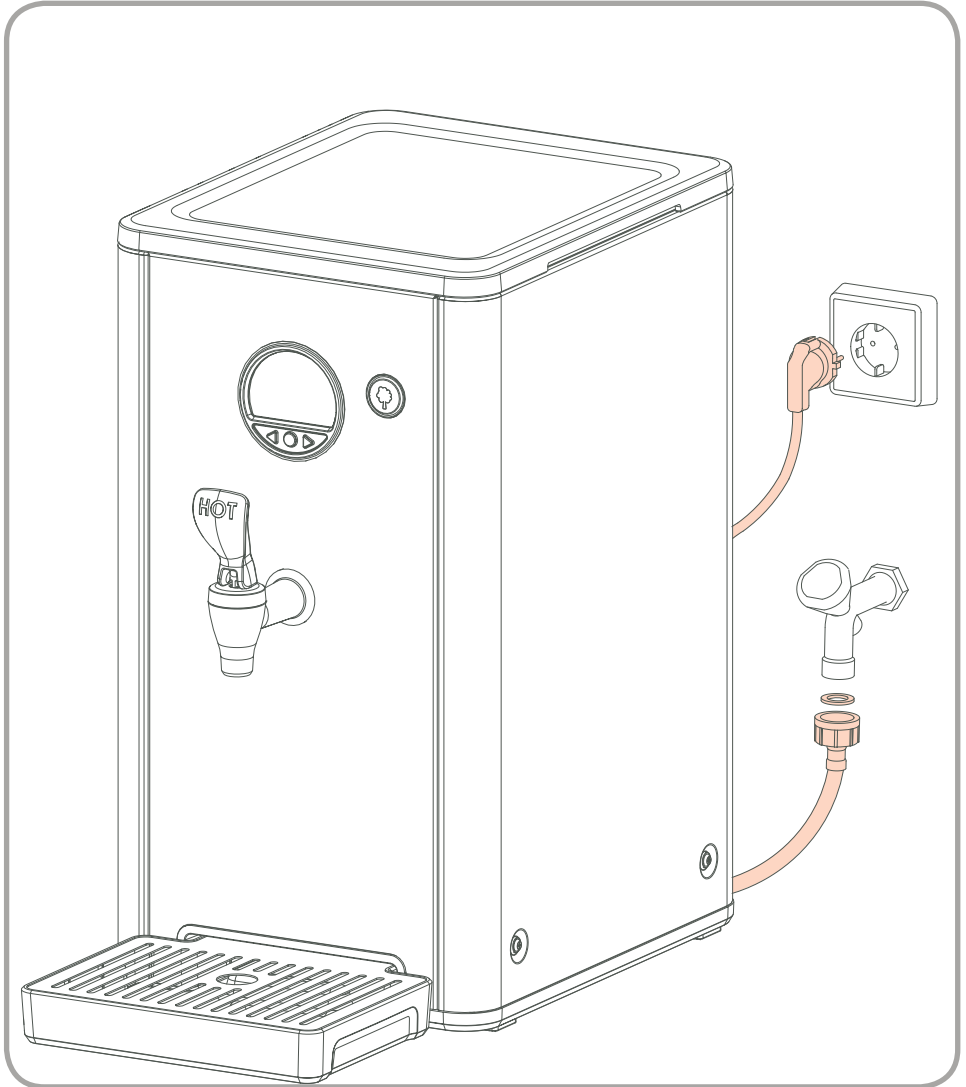

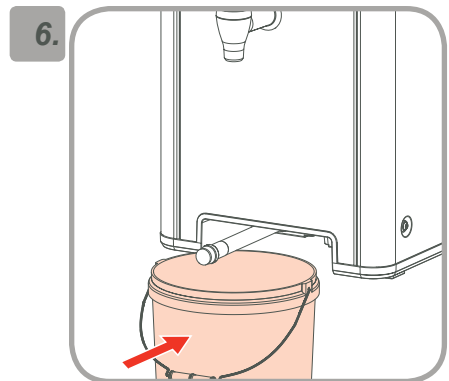
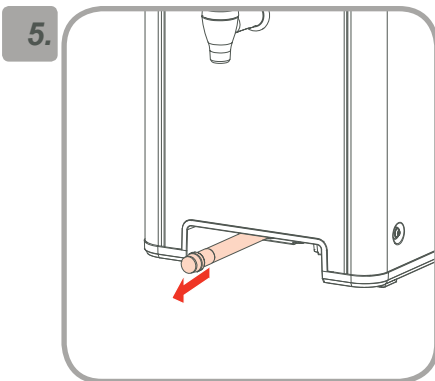
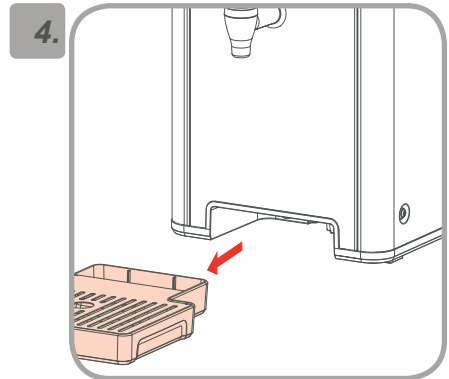
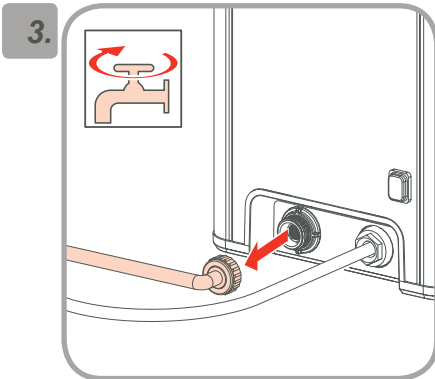
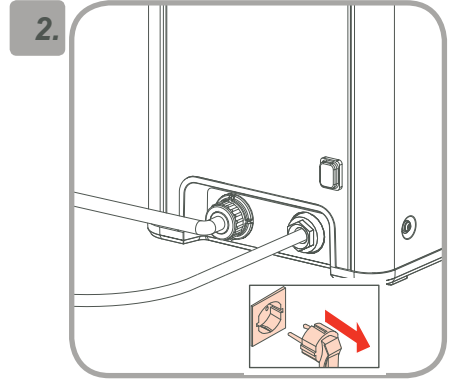
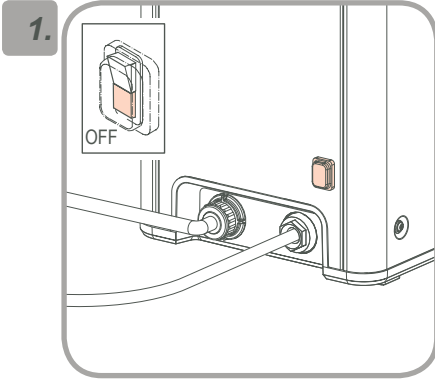

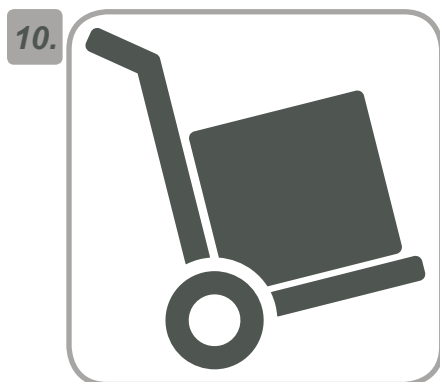
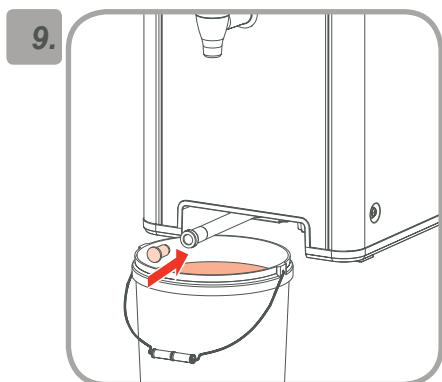
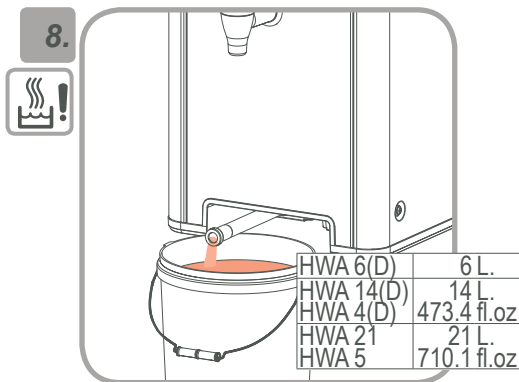
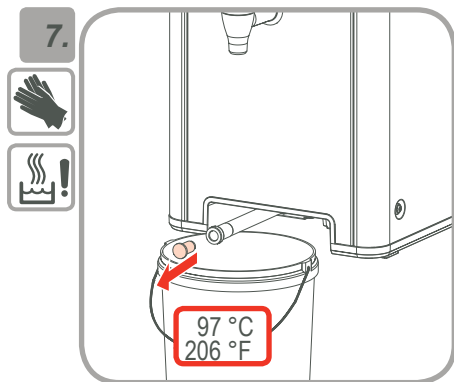

Messages

Messages

Meldungen

Meldingen

Meddelanden

Meldinger

Beskeder

Viestit

Mensajes

Mensagens

Messaggio

Μηνύματα λάθους

Zprávy

Wiadomości

Mesaje

Сообщения

Mesajlar

消息

メッセージ

메시지

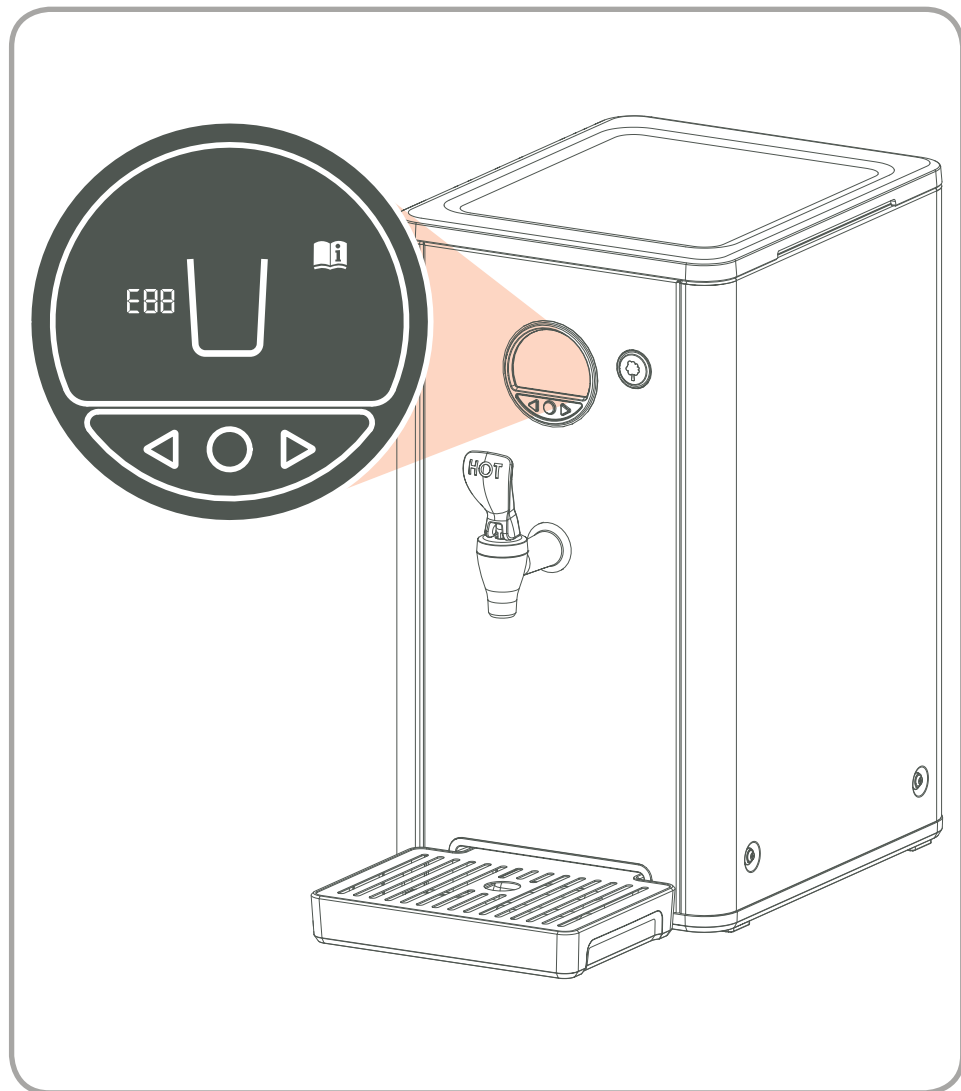

E

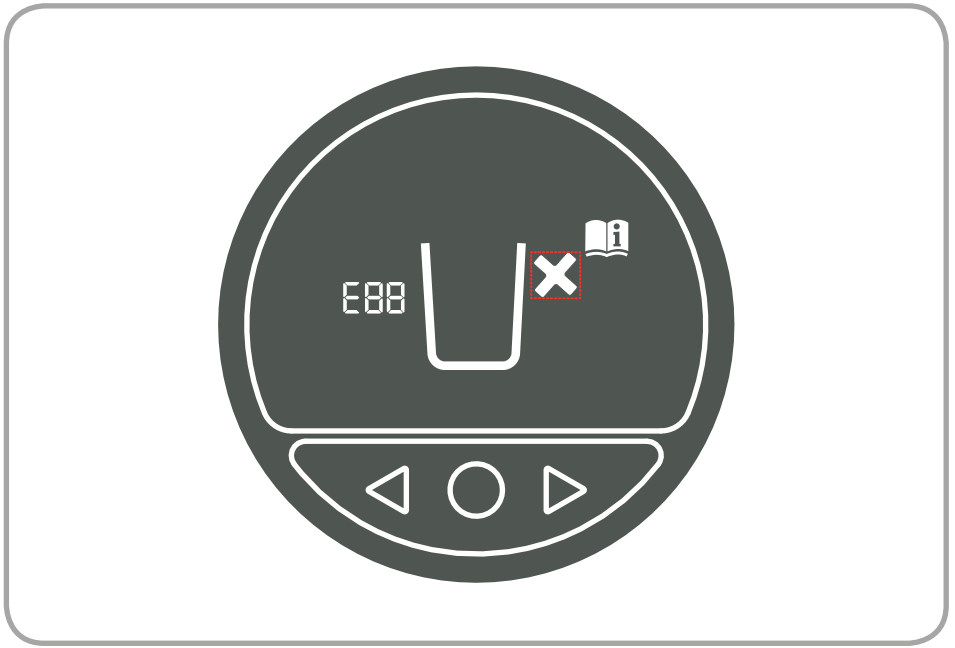

.....

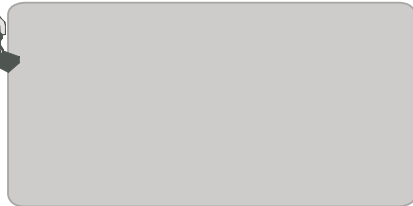



Italiano
Ελληνικά
Česky
Polski
Română

Русский
Türkçe
中國語文
日本語
한국어

Opzione
Προαιρετικός
Nepovinný
Opcja
Optional



Необязательный
Opsiyonel
自選
オプションナル
음션

Accessori
Συνημμένα
Příslušenství
Akcesoria
Accesorii



Аксессуары
Akseuarlar
附件
属品
액세서리

Dosaggio manuale
Εγχειρίδιο δοσολογία
Ruční dávkování
Ręczne dozowanie
Dozare manuală



Руководство
дозирования
Manuel dozajama
手動加藥
マニュアル投与
수동 투약

Dosaggio automatico
Αυτόματη δοσολογία
Automatické
dávkování
Automatyczne
dozowanie
Dozare automata



Автоматическое
дозирование
Otomatik dozajama
自動加藥
自動投与
자동 투약

Attendere
Περιμένετε
Čekajte
Czekaj
Așteaptă



Ждите
Bekle
等待
待つ
잠깐만 요

Detersivo
Απορρυπαντικό
Prostředek na
odvápňení
Środek myjący
Detergent



Уистящее средство
Durula
洗滌劑
洗劑
세정제

Lavaggio
Ξεπλύνετε
Vypláchnout
Płukanie



Прополосать
Durula
冲洗
リンス

Contatore
Μετρητής
Počítadlo
Licznik
Contor



Счетчик
Sayac
計數器
カウンター
카운터

Guanti di protezione
Προστατευτικά γάντια
Ochranné rukavice
Rękawiczki ochronne
Mănuși protecție



Защитные перчатки
Güvenlik eldivenleri
防護手套
保護手袋を
보호 장갑

Occhiali di protezione
Γυαλιά προστασίας
Ochranné brýle
Okulary ochronne
Ochelari protecție



Защитные очки
Güvenlik gözlükleri
護目鏡
安全眼鏡
안전 안경

Liquido caldo
Καυτό υγρό
Horký nápoj
Gorący płyn
Lichid fierbinte



Горячая жидкость
Sıcak sıvı
熱液體
溫液
뜨거운 액체

Vapore!
Ατμού!
Parní!
Parowa!
Abur!



Паровая!
Buhar!
蒸汽!
스팀!
스팀!

Chiamare il fornitore
Πρόσκληση διανομέας
Prodejce hovoru
Teefon do distributora
Cheamă distribuitorul



Вызов
дистрибутор
Çağrı distributorü
呼叫分配器
コールディエラー
전화 대리점

Lampeggiamento
Na αναβοσβήνει
Blikaji
Miga



Мигание
Yanıp sönen
閃爍
点滅します
깜박입니다

Lumina intermitent
Disattivare eco!
Απενεργοποίηση eco!
Eco vypnutí!
Wyłączyc eco!
Dezactivați eco!



Выключите эко!
Eko devre dışı!
停用節能!
エコを
無効にします!
없는 절전!



Italiano
Ελληνικά
Česky
Polski
Română



Русский
Türkçe
中國語文
日本語
한국어

Informazione Πληροφορίες Informace Informacja Informație		Информация Bilgi 情報 정보
Indice Πίνακας περιεχομένων Obsah Spis treści Index		Содержание İçindekiler 目錄 目次 차례
Prescrizioni icurezza Εγχειρίδιο Ασφάλειας Bezpečnostní kniha Wskazówki bezpieczeństwa Carte instructaj		Руководство по безопасности Güvenlik kitabı 安全手冊 安全マニュアル 안전 매뉴얼
Istruzione d'uso Χειρισμός Obsluha Instrukcja obsługi Instalare		Обслуживание Kullanım 處理 取り扱い 취급
Installazione Εγκατάσταση Instalace Instalacja Operare		Устанавливать Yerleştirmek 安裝 設置 설치
Risparmio energetico Που εξοικονομεί ενέργεια Šetření energie Oszczędzanie energii Economisire energie		Энергосбережение Güc tasarrufu 節能 パワーセー빙 절전

Pulizia giornaliera Καθάρισμα, καθημερινά Cistění, denně Czyszczenie, dzienne Curățare, zilnic		Чистка ежедневно Temizlik, günlük 清潔, 每天 毎日、 ケリーニング 매일 청소
Programmazione Προγραμματισμός Programování Programowanie Programare		Программирование Programlama 程序设计 프로그래밍 프로그래밍
Decalcificazione Αφαλάτωση Odvápnění Odkamienianie Decalcarizare		Декальцификация Kirecten arindirma 除垢 스케일 제거 디스케일링
Temperatura di ebollizione Θερμοκρασία βρασμού Bod varu stanovení Okreslenia punktu wrzenia Temperatura de fierbere		Кипение определение Kaynama noktasi tavini 沸點 沸騰溫度 끓는 온도
Calibrazione Βαθμονόμηση Kalibrace Kalibracja Calibrarea		Калибровка Kalibrasyon 校準 キャ 교정
Spostare Μετακινήσετε Přemisovat Przenosić Mutare		Перемещение Hareket ettirmek 移動機 의동기 의동기
Messaggio Μηνύματα λάθους Zprávy Wiadomości Mesaje		Сообщения Mesajlar 消息 メッセージ 메시지



**/// BRAVILOR
BONAMAT**



©
07-2018
VHH